

# ELEVATION CERTIFICATE

**Important:** Follow the instructions on pages 1-9.

Copy all pages of this Elevation Certificate and all attachments for (1) community official, (2) insurance agent/company, and (3) building owner.

SECTION A – PROPERTY INFORMATION				FOR INSURANCE COMPANY USE	
A1. Building Owner's Name William and Betz Stein				Policy Number:	
A2. Building Street Address (including Apt., Unit, Suite, and/or Bldg. No.) or P.O. Route and Box No. 530 Harbor Point Road				Company NAIC Number:	
City Longboat Key		State Florida		ZIP Code 34228	
A3. Property Description (Lot and Block Numbers, Tax Parcel Number, Legal Description, etc.) Lot 51, Bay Isles Unit No. 1					
A4. Building Use (e.g., Residential, Non-Residential, Addition, Accessory, etc.) <u>Residential</u>					
A5. Latitude/Longitude: Lat. <u>N 27.353040</u> Long. <u>W 82.608006</u> Horizontal Datum: <input type="checkbox"/> NAD 1927 <input checked="" type="checkbox"/> NAD 1983					
A6. Attach at least 2 photographs of the building if the Certificate is being used to obtain flood insurance.					
A7. Building Diagram Number <u>1B</u>					
A8. For a building with a crawlspace or enclosure(s):					
a) Square footage of crawlspace or enclosure(s) <u>0</u> sq ft					
b) Number of permanent flood openings in the crawlspace or enclosure(s) within 1.0 foot above adjacent grade <u>0</u>					
c) Total net area of flood openings in A8.b <u>0</u> sq in					
d) Engineered flood openings? <input type="checkbox"/> Yes <input type="checkbox"/> No					
A9. For a building with an attached garage:					
a) Square footage of attached garage <u>894</u> sq ft					
b) Number of permanent flood openings in the attached garage within 1.0 foot above adjacent grade <u>5</u>					
c) Total net area of flood openings in A9.b <u>185</u> sq in					
d) Engineered flood openings? <input checked="" type="checkbox"/> Yes <input type="checkbox"/> No					
SECTION B – FLOOD INSURANCE RATE MAP (FIRM) INFORMATION					
B1. NFIP Community Name & Community Number 125126 Longboat Key, Town Of			B2. County Name Sarasota		B3. State Florida
B4. Map/Panel Number 12115C0126	B5. Suffix F	B6. FIRM Index Date 11/04/2016	B7. FIRM Panel Effective/ Revised Date 11/04/2016	B8. Flood Zone(s) AE	B9. Base Flood Elevation(s) (Zone AO, use Base Flood Depth) 11
B10. Indicate the source of the Base Flood Elevation (BFE) data or base flood depth entered in Item B9: <input type="checkbox"/> FIS Profile <input checked="" type="checkbox"/> FIRM <input type="checkbox"/> Community Determined <input type="checkbox"/> Other/Source: _____					
B11. Indicate elevation datum used for BFE in Item B9: <input type="checkbox"/> NGVD 1929 <input checked="" type="checkbox"/> NAVD 1988 <input type="checkbox"/> Other/Source: _____					
B12. Is the building located in a Coastal Barrier Resources System (CBRS) area or Otherwise Protected Area (OPA)? <input type="checkbox"/> Yes <input checked="" type="checkbox"/> No Designation Date: _____ <input type="checkbox"/> CBRS <input type="checkbox"/> OPA					

RECEIVED

MAY 31 2019

**ELEVATION CERTIFICATE**

OMB No. 1660-0008  
Expiration Date: November 30, 2018

<b>IMPORTANT: In these spaces, copy the corresponding information from Section A.</b>			<b>FOR INSURANCE COMPANY USE</b>
Building Street Address (including Apt., Unit, Suite, and/or Bldg. No.) or P.O. Route and Box No. 530 Harbor Point Road			Policy Number:
City Longboat Key	State Florida	ZIP Code 34228	Company NAIC Number

**SECTION C – BUILDING ELEVATION INFORMATION (SURVEY REQUIRED)**

C1. Building elevations are based on:  Construction Drawings\*  Building Under Construction\*  Finished Construction

\*A new Elevation Certificate will be required when construction of the building is complete.

C2. Elevations – Zones A1–A30, AE, AH, A (with BFE), VE, V1–V30, V (with BFE), AR, AR/A, AR/AE, AR/A1–A30, AR/AH, AR/AO. Complete Items C2.a–h below according to the building diagram specified in Item A7. In Puerto Rico only, enter meters.

Benchmark Utilized: NGS A 715 Vertical Datum: 7.74

Indicate elevation datum used for the elevations in items a) through h) below.

NGVD 1929  NAVD 1988  Other/Source: \_\_\_\_\_

Datum used for building elevations must be the same as that used for the BFE.

Check the measurement used.

- a) Top of bottom floor (including basement, crawlspace, or enclosure floor) 12.6  feet  meters
- b) Top of the next higher floor 23.3  feet  meters
- c) Bottom of the lowest horizontal structural member (V Zones only) N/A  feet  meters
- d) Attached garage (top of slab) 8.4  feet  meters
- e) Lowest elevation of machinery or equipment servicing the building (Describe type of equipment and location in Comments) 12.9  feet  meters
- f) Lowest adjacent (finished) grade next to building (LAG) 7.1  feet  meters
- g) Highest adjacent (finished) grade next to building (HAG) 7.8  feet  meters
- h) Lowest adjacent grade at lowest elevation of deck or stairs, including structural support 4.5  feet  meters

**SECTION D – SURVEYOR, ENGINEER, OR ARCHITECT CERTIFICATION**

This certification is to be signed and sealed by a land surveyor, engineer, or architect authorized by law to certify elevation information. I certify that the information on this Certificate represents my best efforts to interpret the data available. I understand that any false statement may be punishable by fine or imprisonment under 18 U.S. Code, Section 1001.

Were latitude and longitude in Section A provided by a licensed land surveyor?  Yes  No  Check here if attachments.

Certifier's Name James Burchett		License Number LS 5701	
Title President			
Company Name Sampey, Burchett and Knight, Inc.			
Address 1570 Global Court			
City Sarasota	State Florida	ZIP Code 34240	
Signature J.B. Burchett	Date 05/17/2019	Telephone (941) 342-0349	

Copy all pages of this Elevation Certificate and all attachments for (1) community official, (2) insurance agent/company, and (3) building owner.

Comments (including type of equipment and location, per C2(e), if applicable)  
C2 (e), Generator on the right side of the house.  
A9, 5 Flood Flap flood vents FFWF 12TF-W were used providing 220 sq. ft. of coverage each totaling 1,100 sq. ft. of coverage.



**ELEVATION CERTIFICATE**

OMB No. 1660-0008  
Expiration Date: November 30, 2018

<b>IMPORTANT: In these spaces, copy the corresponding information from Section A.</b>			<b>FOR INSURANCE COMPANY USE</b>
Building Street Address (including Apt., Unit, Suite, and/or Bldg. No.) or P.O. Route and Box No. 530 Harbor Point Road			Policy Number:
City Longboat Key	State Florida	ZIP Code 34228	Company NAIC Number

**SECTION E – BUILDING ELEVATION INFORMATION (SURVEY NOT REQUIRED)  
FOR ZONE AO AND ZONE A (WITHOUT BFE)**

For Zones AO and A (without BFE), complete Items E1–E5. If the Certificate is intended to support a LOMA or LOMR-F request, complete Sections A, B, and C. For Items E1–E4, use natural grade, if available. Check the measurement used. In Puerto Rico only, enter meters.

- E1. Provide elevation information for the following and check the appropriate boxes to show whether the elevation is above or below the highest adjacent grade (HAG) and the lowest adjacent grade (LAG).
- a) Top of bottom floor (including basement, crawlspace, or enclosure) is \_\_\_\_\_ . \_\_\_\_\_  feet  meters  above or  below the HAG.
- b) Top of bottom floor (including basement, crawlspace, or enclosure) is \_\_\_\_\_ . \_\_\_\_\_  feet  meters  above or  below the LAG.
- E2. For Building Diagrams 6–9 with permanent flood openings provided in Section A Items 8 and/or 9 (see pages 1–2 of Instructions), the next higher floor (elevation C2.b in the diagrams) of the building is \_\_\_\_\_ . \_\_\_\_\_  feet  meters  above or  below the HAG.
- E3. Attached garage (top of slab) is \_\_\_\_\_ . \_\_\_\_\_  feet  meters  above or  below the HAG.
- E4. Top of platform of machinery and/or equipment servicing the building is \_\_\_\_\_ . \_\_\_\_\_  feet  meters  above or  below the HAG.
- E5. Zone AO only: If no flood depth number is available, is the top of the bottom floor elevated in accordance with the community's floodplain management ordinance?  Yes  No  Unknown. The local official must certify this information in Section G.

**SECTION F – PROPERTY OWNER (OR OWNER'S REPRESENTATIVE) CERTIFICATION**

The property owner or owner's authorized representative who completes Sections A, B, and E for Zone A (without a FEMA-issued or community-issued BFE) or Zone AO must sign here. The statements in Sections A, B, and E are correct to the best of my knowledge.

Property Owner or Owner's Authorized Representative's Name \_\_\_\_\_

Address	City	State	ZIP Code
Signature	Date	Telephone	

Comments \_\_\_\_\_

**RECEIVED**  
 Check here if attachments.

**ELEVATION CERTIFICATE**

OMB No. 1660-0008  
Expiration Date: November 30, 2018

<b>IMPORTANT: In these spaces, copy the corresponding information from Section A.</b>			<b>FOR INSURANCE COMPANY USE</b>
Building Street Address (including Apt., Unit, Suite, and/or Bldg. No.) or P.O. Route and Box No. 530 Harbor Point Road			Policy Number:
City Longboat Key	State Florida	ZIP Code 34228	Company NAIC Number

**SECTION G – COMMUNITY INFORMATION (OPTIONAL)**

The local official who is authorized by law or ordinance to administer the community's floodplain management ordinance can complete Sections A, B, C (or E), and G of this Elevation Certificate. Complete the applicable item(s) and sign below. Check the measurement used in Items G8–G10. In Puerto Rico only, enter meters.

- G1.  The information in Section C was taken from other documentation that has been signed and sealed by a licensed surveyor, engineer, or architect who is authorized by law to certify elevation information. (Indicate the source and date of the elevation data in the Comments area below.)
- G2.  A community official completed Section E for a building located in Zone A (without a FEMA-issued or community-issued BFE) or Zone AO.
- G3.  The following information (Items G4–G10) is provided for community floodplain management purposes.

G4. Permit Number	G5. Date Permit Issued	G6. Date Certificate of Compliance/Occupancy Issued
-------------------	------------------------	---

G7. This permit has been issued for:  New Construction  Substantial Improvement

G8. Elevation of as-built lowest floor (including basement) of the building: \_\_\_\_\_  feet  meters Datum \_\_\_\_\_

G9. BFE or (in Zone AO) depth of flooding at the building site: \_\_\_\_\_  feet  meters Datum \_\_\_\_\_

G10. Community's design flood elevation: \_\_\_\_\_  feet  meters Datum \_\_\_\_\_

Local Official's Name	Title
-----------------------	-------

Community Name	Telephone
----------------	-----------

Signature	Date
-----------	------

Comments (including type of equipment and location, per C2(e), if applicable)

**RECEIVED**

Check here if attachments. **MAY 31 2018**



## BUILDING PHOTOGRAPHS

OMB No. 1660-0008  
Expiration Date: November 30, 2018

### ELEVATION CERTIFICATE

See Instructions for Item A6.

<b>IMPORTANT: In these spaces, copy the corresponding information from Section A.</b>			<b>FOR INSURANCE COMPANY USE</b>
Building Street Address (including Apt., Unit, Suite, and/or Bldg. No.) or P.O. Route and Box No. 530 Harbor Point Road			Policy Number:
City Longboat Key	State Florida	ZIP Code 34228	Company NAIC Number

If using the Elevation Certificate to obtain NFIP flood insurance, affix at least 2 building photographs below according to the instructions for Item A6. Identify all photographs with date taken; "Front View" and "Rear View"; and, if required, "Right Side View" and "Left Side View." When applicable, photographs must show the foundation with representative examples of the flood openings or vents, as indicated in Section A8. If submitting more photographs than will fit on this page, use the Continuation Page.



Photo One

Photo One Caption Front

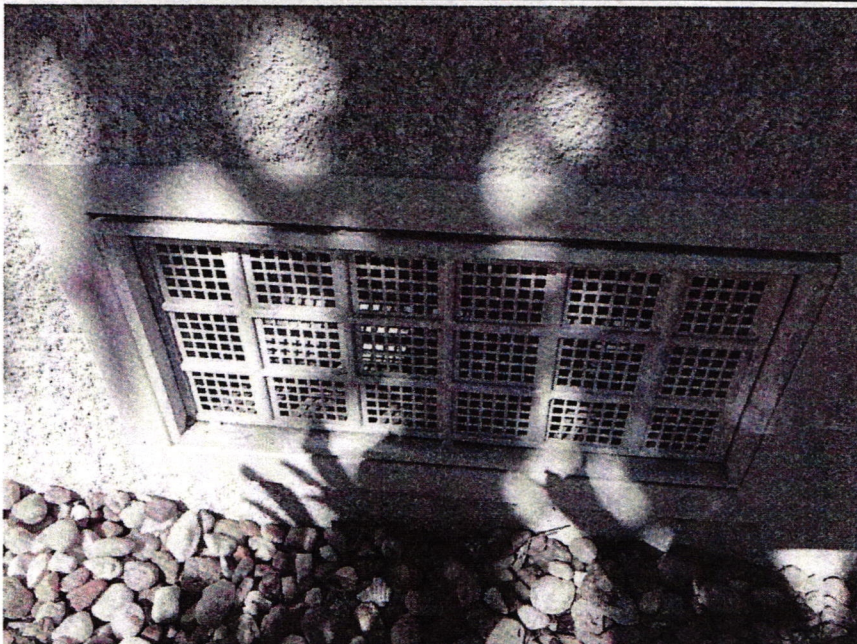

Photo Two

Photo Two Caption Flood Flap Flood Vent

RECEIVED

MAY 31 2019



## BUILDING PHOTOGRAPHS

OMB No. 1660-0008  
Expiration Date: November 30, 2018

### ELEVATION CERTIFICATE

Continuation Page

<b>IMPORTANT: In these spaces, copy the corresponding information from Section A.</b>			<b>FOR INSURANCE COMPANY USE</b>
Building Street Address (including Apt., Unit, Suite, and/or Bldg. No.) or P.O. Route and Box No. 530 Harbor Point Road			Policy Number:
City Longboat Key	State Florida	ZIP Code 34228	Company NAIC Number

If submitting more photographs than will fit on the preceding page, affix the additional photographs below. Identify all photographs with: date taken; "Front View" and "Rear View"; and, if required, "Right Side View" and "Left Side View." When applicable, photographs must show the foundation with representative examples of the flood openings or vents, as indicated in Section A8.

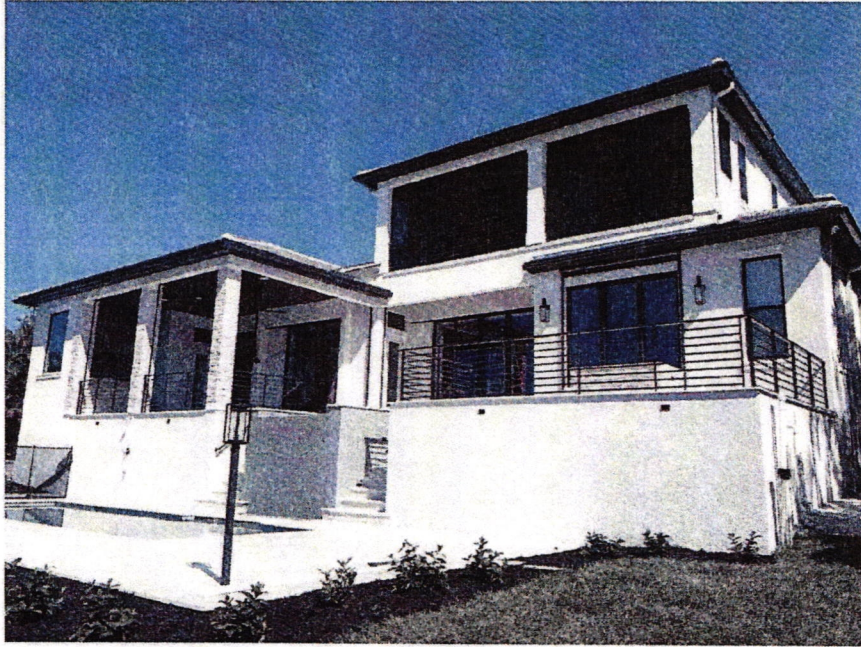

Photo One

Photo One Caption Rear



Photo Two

Photo Two Caption Right Side

RECEIVED

MAY 31 2019





*Most Widely Accepted and Trusted*

# ICC-ES Evaluation Report

# ESR-3560

ICC-ES | (800) 423-6587 | (562) 699-0543 | [www.icc-es.org](http://www.icc-es.org)

Reissued 09/2018  
This report is subject to renewal 09/2019.

**DIVISION: 08 00 00—OPENINGS**

**SECTION: 08 95 43—VENTS/FOUNDATION FLOOD VENTS**

**REPORT HOLDER:**

**FLOOD FLAPS<sup>®</sup>, LLC**

**EVALUATION SUBJECT:**

**FLOOD FLAPS<sup>®</sup> AUTOMATIC FLOOD VENTS:  
MODELS FFWF12; FFNF12; FFWF08; FFNF08; FFWF05; FFNF05**



*"2014 Recipient of Prestigious Western States Seismic Policy Council (WSSPC) Award in Excellence"*



*ICC-ES Evaluation Reports are not to be construed as representing aesthetics or any other attributes not specifically addressed, nor are they to be construed as an endorsement of the subject of the report or a recommendation for its use. There is no warranty by ICC Evaluation Service, LLC, express or implied, as to any finding or other matter in this report, or as to any product covered by the report.*



Copyright © 2018 ICC Evaluation Service, LLC. All rights reserved.



# ICC-ES Evaluation Report

**ESR-3560**

Reissued September 2018

This report is subject to renewal September 2019.

[www.icc-es.org](http://www.icc-es.org) | (800) 423-6587 | (562) 699-0543

A Subsidiary of the International Code Council®

**DIVISION: 08 00 00—OPENINGS**

**Section: 08 95 43—Vents/Foundation Flood Vents**

**REPORT HOLDER:**

FLOOD FLAPS®, LLC

**EVALUATION SUBJECT:**

FLOOD FLAPS® AUTOMATIC FLOOD VENTS: MODELS  
FFWF12; FFNF12; FFWF08; FFNF08; FFWF05; FFNF05

## 1.0 EVALUATION SCOPE

**Compliance with the following codes:**

- 2018, 2015, 2012 and 2009 *International Building Code*® (IBC)
- 2018, 2015, 2012 and 2009 *International Residential Code*® (IRC)

**Properties evaluated:**

- Physical operation
- Water flow
- Weathering

## 2.0 USES

Flood Flaps® automatic flood vents are used to provide for the equalization of hydrostatic flood forces on exterior walls. Certain models also allow natural ventilation.

## 3.0 DESCRIPTION

### 3.1 General:

Flood Flaps® automatic flood vents are engineered mechanically operated flood vents (FVs) that automatically allow flood waters to enter and exit enclosed areas. The FVs are constructed of ABS plastic which serves as the FV's housing, and a front grill that contains an anodized metal screen imbedded in polypropylene plastic. On contact with rising flood water, the grill will disengage from its secured position, allowing flood water and debris to flow through in either direction. The FVs are available in two series as described in Section 3.3.

The sealed series models contain two rubber flaps that close the FV to the passage of air when using with conditioned areas or sealed crawl spaces. In the same manner as the grill, the two rubber flaps are pushed open by water pressure, allowing water and debris to flow through the FV in either direction. See Figure 1 for an illustration of the Flood Flaps® automatic FV.

### 3.2 Engineered Opening:

The Flood Flaps® automatic FVs comply with the design principle noted in Sections 2.7.2.2 and 2.7.3 of ASCE/SEI 24-14 (2018 and 2015 IBC and IRC) [Section 2.6.2.2 of ASCE/SEI 24-05 (2012 and 2009 IBC and IRC)] for a rate of rise and fall of 5 feet per hour (0.423 mm/s). In order to comply with the engineered opening requirement of ASCE/SEI 24, Flood Flaps® automatic FVs must be installed in accordance with Section 4.0.

### 3.3 Flood Vent Series Models:

Flood Flaps® automatic FVs are available in two series with multiple models and sizes as described in Table 1. The sealed series models, designated FFWF, include two rubber flaps for the prevention of air flow. The multi-purpose series, designated FFNF, omits the rubber flaps.

### 3.4 Natural Ventilation:

Flood Flaps® automatic FV models FFNF12, FFNF08, FFNF05, and FFNF02 have metal screens with 1/4 inch by 1/4 inch (6 mm by 6 mm) openings and provide 37 square inches (0.02 m<sup>2</sup>) of net free opening to supply natural ventilation for under-floor ventilation. Flood Flaps® automatic FV models FFWF12, FFWF08, and FFWF05 have not been evaluated for use as openings for under-floor ventilation.

## 4.0 DESIGN AND INSTALLATION

Flood Flaps® automatic FVs are designed to be installed into walls of existing or new construction. Installation of the FVs must be in accordance with the manufacturer's instructions, the applicable code and this report. Flood Flaps® automatic FVs can be installed in wood, masonry and concrete walls up to a thickness of 12 inches (305 mm). In order to comply with the engineered opening design principle noted in Sections 2.7.2.2 and 2.7.3 of ASCE/SEI 24-14 (2018 and 2015 IBC and IRC) [Section 2.6.2.2 of ASCE/SEI 24-05 (2012 and 2009 IBC and IRC)], the Flood Flaps® FVs must be installed as follows:

- With a minimum of two openings on different sides of each enclosed area.
- With a minimum of one FV for every 220 square feet (20 m<sup>2</sup>) of enclosed area.
- Below the base flood elevation.
- With the bottom of the FV located a maximum of 12 inches (305 mm) above grade.

## 5.0 CONDITIONS OF USE

The Flood Flaps® automatic flood vents described in this report comply with, or are suitable alternatives to what is



specified in, those codes listed in Section 1.0 of this report, subject to the following conditions:

- 5.1 The Flood Flaps® automatic FVs must be installed in accordance with this report, the applicable code and the manufacturer’s installation instructions. In the event of a conflict, the instructions in this report govern.
- 5.2 The Flood Flaps® automatic FVs must not be used in place of “breakaway walls” in coastal high hazard areas, but are permitted for use in conjunction with breakaway walls in other areas.

**6.0 EVIDENCE SUBMITTED**

Data in accordance with the ICC-ES Acceptance Criteria for Mechanically Operated Flood Vents (AC364), dated August 2015 (editorially revised October 2017).

**7.0 IDENTIFICATION**

- 7.1 The Flood Flaps® models recognized in this report are identified by a label bearing the manufacturer’s name, the model number, and the evaluation report number (ESR-3560).

7.2 The report holder’s contact information is the following:

**FLOOD FLAPS®, LLC**  
**POST OFFICE BOX 1003**  
**ISLE OF PALMS, SOUTH CAROLINA 29451**  
**(843) 881-0190**  
[www.floodflaps.com](http://www.floodflaps.com)  
[info@floodflaps.com](mailto:info@floodflaps.com)

**TABLE 1—FLOOD FLAP AUTOMATIC FLOOD VENT MODEL SIZES**

MODEL NUMBER	MODEL DESIGNATION	ROUGH OPENING (Width X Height) (inches)	VENT SIZE (W X H X D) (inches)	ENCLOSED AREA COVERAGE (ft <sup>2</sup> )	NET FREE AREA OPENING <sup>1</sup> (in <sup>2</sup> )
FFWF12	Sealed Series	16 x 8	15 <sup>5</sup> / <sub>8</sub> X 7 <sup>3</sup> / <sub>4</sub> X 12	220	NA
FFNF12	Multi-Purpose	16 x 8	15 <sup>5</sup> / <sub>8</sub> X 7 <sup>3</sup> / <sub>4</sub> X 12	220	37
FFWF08	Sealed Series	16 x 8	15 <sup>5</sup> / <sub>8</sub> X 7 <sup>3</sup> / <sub>4</sub> X 8	220	NA
FFNF08	Multi-Purpose	16 x 8	15 <sup>5</sup> / <sub>8</sub> X 7 <sup>3</sup> / <sub>4</sub> X 8	220	37
FFWF05	Sealed Series	16 x 8	15 <sup>5</sup> / <sub>8</sub> X 7 <sup>3</sup> / <sub>4</sub> X 5	220	NA
FFNF05	Multi-Purpose	16 x 8	15 <sup>5</sup> / <sub>8</sub> X 7 <sup>3</sup> / <sub>4</sub> X 5	220	37

For SI: 1 inch = 25.4 mm; 1 ft<sup>2</sup> = 0.093 m<sup>2</sup>

<sup>1</sup>For under-floor ventilation only.

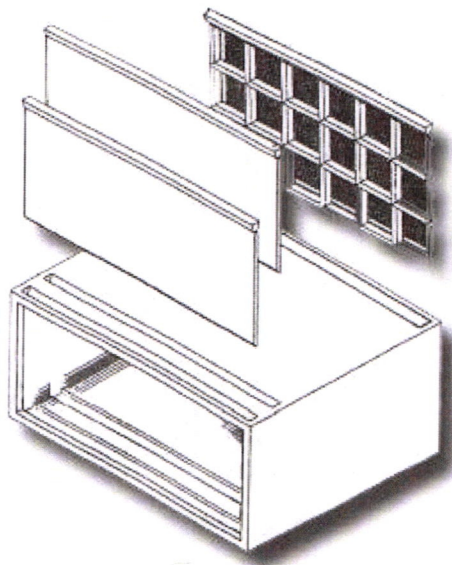

**FIGURE 1—FLOOD FLAPS® AUTOMATIC FLOOD VENT**

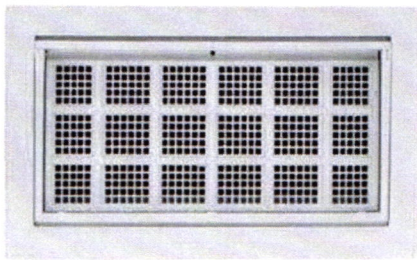

FFWF12

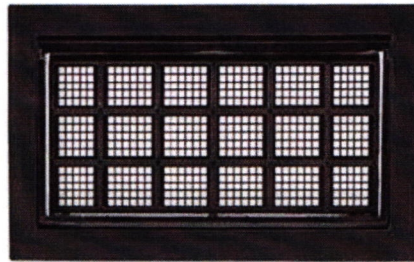

FFNF08

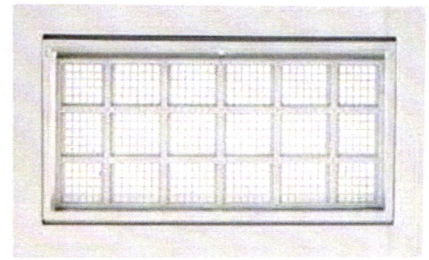

FFNF05

FIGURE 2—FLOOD FLAPS® AUTOMATIC FLOOD VENT SERIES MODELS

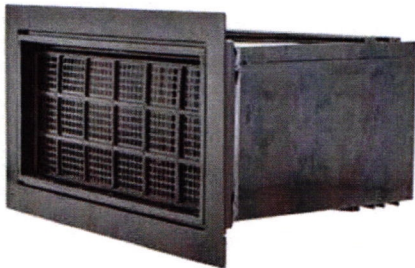

12" DEPTH

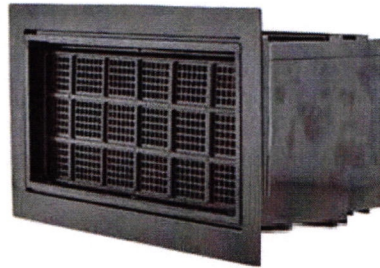

8" DEPTH

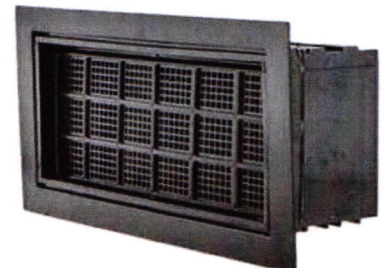

5" DEPTH

FIGURE 3—FLOOD FLAPS® AUTOMATIC FLOOD VENTS MULTIPLE DEPTH OFFERINGS



## ICC-ES Evaluation Report

## ESR-3560 FBC Supplement

Reissued September 2018

This report is subject to renewal September 2019.

[www.icc-es.org](http://www.icc-es.org) | (800) 423-6587 | (562) 699-0543 | A Subsidiary of the International Code Council®

DIVISION: 08 00 00—OPENINGS

Section: 08 95 43—Vents/Foundation Flood Vents

REPORT HOLDER:

FLOOD FLAPS®, LLC

EVALUATION SUBJECT:

FLOOD FLAPS® AUTOMATIC FLOOD VENTS: MODELS FFWF12; FFNF12; FFWF08; FFNF08; FFWF05; FFNF05

### 1.0 REPORT PURPOSE AND SCOPE

#### Purpose:

The purpose of this evaluation report supplement is to indicate that Flood Flaps® automatic flood vents, recognized in ICC-ES master evaluation report ESR-3560, have also been evaluated for compliance with the codes noted below.

#### Applicable code editions:

- 2017 Florida Building Code—Building
- 2017 Florida Building Code—Residential

### 2.0 CONCLUSIONS

The Flood Flaps flood vents, described in Sections 2.0 through 7.0 of the master evaluation report ESR-3560, comply with the *Florida Building Code—Building* and the *Florida Building Code—Residential*, provided the design and installation are in accordance with the 2015 *International Building Code*® provisions noted in the master report.

Use of the Flood Flaps flood vents has also been found to be in compliance with the High-Velocity Hurricane Zone provisions of the *Florida Building Code—Building* and the *Florida Building Code—Residential*.

For products falling under Florida Rule 9N-3, verification that the report holder's quality-assurance program is audited by a quality-assurance entity approved by the Florida Building Commission for the type of inspections being conducted is the responsibility of an approved validation entity (or the code official, when the report holder does not possess an approval by the Commission).

This supplement expires concurrently with the master report, reissued September 2018.



# TRANSMITTAL FORM

Town of Longboat Key  
Planning, Zoning & Building Department  
501 Bay Isles Road  
Longboat Key, Florida 34228  
941-316-1966  
941-316-1970 Fax

DATE: 5/28/19 ATTN: Patti  
FROM: Darrel Ashby  
Company: John Cannon Homes  
Phone: 941-924-5935 Email: dashby@johncannonhomes.com

SITE LOCATION/ADDRESS: 530 Harbor Point Rd.

PERMIT NUMBER: PB17-0428

THE FOLLOWING IS SUBMITTED FOR CONSIDERATION BY PZB STAFF

RESPONSE TO COMMENTS

REVISIONS / RE-SUBMITTALS

OTHER: \_\_\_\_\_

### APPLICABLE CODES / TRADES (Check All That Apply):

BUILDING / FEMA  
 ZONING

ELECTRICAL  
 GAS VENTING

HVAC  
 GAS PIPING

PLUMBING  
 FIRE MARSHAL

### ITEMS INCLUDED IN THIS TRANSMITTAL:

FEMA elevation certificate ✓ P.F. 6/1/19 - Approved  
Final Survey  
\_\_\_\_\_  
\_\_\_\_\_  
\_\_\_\_\_

RECEIVED

MAY 31 2019

TOWN OF LONGBOAT KEY  
Planning, Zoning & Building