



# FLORIDA DEPARTMENT OF Environmental Protection

**Ron DeSantis**  
Governor

**Jeanette Nuñez**  
Lt. Governor

**Shawn Hamilton**  
Secretary

Southwest District Office  
13051 North Telecom Parkway #101  
Temple Terrace, Florida 33637-0926

January 27, 2022

Town of Longboat Key  
c/o Isaac Brownman, Director of Public Works  
600 General Harris St.  
Longboat Key, FL 34228-1412  
[ibrownman@longboatkey.org](mailto:ibrownman@longboatkey.org)

Dear Mr. Brownman:

Enclosed is the Environmental Resource Permit, DEP Project No. 41-0393941-001-EI, issued pursuant to Part IV of Chapter 373, Florida Statutes, and Title 62, Florida Administrative Code.

Appeal rights for you and for any affected third party are described in the text of the permit along with conditions that must be met when authorized activities are undertaken.

You, as the applicant, are responsible for all aspects of permit compliance. You should therefore review this permit document carefully to ensure compliance with the general conditions and specific conditions contained herein. Please be aware of permit General Condition number 4, which states, "At least 48 hours prior to beginning the authorized activities, the permittee shall submit to the Agency a fully executed Form 62-330.350(1), "Construction Commencement Notice"."

If you have any questions about this document, please contact me at [Carla.Burmann@dep.state.fl.us](mailto:Carla.Burmann@dep.state.fl.us) or (813) 470-5763. Thank you for your participation in the permit process and in managing the natural resources of the State of Florida.

Sincerely,

A handwritten signature in black ink that reads "Carla S. Burmann".

Carla S. Burmann, M.S., C.W.E.  
Environmental Manager  
Permitting and Waste Cleanup Program

cc: Carla Burmann, Southwest District, [carla.burmann@floridadep.gov](mailto:carla.burmann@floridadep.gov)  
ERP Permitting, Southwest District, [sw\\_erp@floridadep.gov](mailto:sw_erp@floridadep.gov)  
U.S. Army Corps of Engineers, [tampareg@usace.army.mil](mailto:tampareg@usace.army.mil)  
Ricardo Borromeo, Carollo Engineers, [rborromeo@carollo.com](mailto:rborromeo@carollo.com)  
Doug Robison, ESA, [drobison@esassoc.com](mailto:drobison@esassoc.com)

Enclosure: Environmental Resource Permit with Attachments (91 pages)



# FLORIDA DEPARTMENT OF Environmental Protection

Southwest District Office  
13051 North Telecom Parkway #101  
Temple Terrace, Florida 33637-0926

**Ron DeSantis**  
Governor

**Jeanette Nuñez**  
Lt. Governor

**Shawn Hamilton**  
Secretary

## **Permittee/Authorized Entity:**

Town of Longboat Key  
c/o Isaac Brownman, Director of Public Works  
600 General Harris St.  
Longboat Key, FL 34228-1412

## **Town of Longboat Key - Redundant Sewer Force Main**

### **Authorized Agent:**

Carollo Engineers  
c/o Ricardo Borromeo  
10117 Princess Palm Ave.  
Tampa, FL 33610-8302

## **Individual Environmental Resource Permit**

**State-owned Submerged Lands Authorization – Pending**

**U.S. Army Corps of Engineers Authorization – Not Approved**

**Permit No.: 41-0393941-001-EI**

**Permit Issuance Date: 1/27/2022**

**Permit Construction Phase Expiration Date: 1/27/2027**





# FLORIDA DEPARTMENT OF Environmental Protection

Southwest District Office  
13051 North Telecom Parkway #101  
Temple Terrace, Florida 33637-0926

**Ron DeSantis**  
Governor

**Jeanette Nuñez**  
Lt. Governor

**Shawn Hamilton**  
Secretary

## Consolidated Environmental Resource Permit and Recommended Intent to Grant Sovereignty Submerged Lands Authorization

**Permittee: Town of Longboat Key**  
**Permit No: 41-0393941-001-EI**

### PROJECT LOCATION

The activities authorized by this permit and sovereignty submerged lands authorization are located from the barrier island at Latitude 27°24'57.4970/Longitude -82°39'16.9880 to the mainland at Latitude 27°25'59.9609/Longitude -82°37'43.2866" from West to East within Sarasota Bay, in Longboat Key, Florida 34228, Section 25, Township 35 South, Range 16 East, Sections 18 and 20, Township 35S, Range 17E, Manatee County.

### PROJECT DESCRIPTION

The permittee is authorized to construct an open-cut trench for the installation of a subaqueous redundant domestic wastewater force main within Sarasota Bay, a Class II Outstanding Florida Waterbody. The proposed work will include permanent impacts to 0.17 acres of freshwater marsh (FLUCCS 641), 0.79 acres of mangroves (FLUCCS 612), 1.91 acres of seagrass (*Halodule wrightii* and *Thalassia testudinum*) (FLUCCS 645), and 0.11 acres of oyster bars (FLUCCS 654) as part of the construction of the project. Additionally, temporary impacts to 2.41 acres of seagrass (FLUCCS 645) will occur due to construction of the force main.

To offset unavoidable impacts that will occur from these authorized activities, the permittee is authorized to create/restore 0.17 acres of freshwater marsh wetlands, restore/enhance 1.18 acres of mangrove habitat, relocate/enhance 0.22 acres of oyster beds, and create an 8.64-acre seagrass planting site, within Sarasota Bay, a Class II Outstanding Florida Waterbody. Creation of the seagrass planting area will include depositing clean compatible sediment material to attain design depths within the photic zone and transplanting approximately 1.5-acres of seagrass from the direct impact areas.

Authorized activities are depicted on the attached exhibits.

### AUTHORIZATIONS

#### Environmental Resource Permit

The Department has determined that the activity qualifies for an Environmental Resource Permit. Therefore, the Environmental Resource Permit is hereby granted, pursuant to Part IV of Chapter 373, Florida Statutes (F.S.), and Chapter 62-330, Florida Administrative Code (F.A.C.).

#### Sovereignty Submerged Lands Authorization

The activity is located on sovereignty submerged lands owned by the State of Florida. It therefore also requires authorization from the Board of Trustees of the Internal Improvement Trust Fund (Board of Trustees), pursuant to

Article X, Section 11 of the Florida Constitution, and Section 253.77, F.S., and Chapter 258, F.S. As staff to the Board of Trustees under Sections 253.002, F.S., the Department has determined that the activity qualifies for and requires a public easement, as long as the work performed is located within the boundaries as described and is consistent with the terms and conditions herein.

The final documents required to execute the public easement will be sent to the permittee by the Department's Division of State Lands for execution. The Department intends to issue the public easement, upon satisfactory execution of those documents, including payment of required fees and compliance with the conditions in the attached permit. **You may not begin construction of the activities described until you receive a copy of the executed public easement from the Department.**

#### Federal Authorization

Your proposed activity as outlined on your application and attached drawings **does not qualify** for Federal authorization pursuant to the State Programmatic General Permit and a **SEPARATE permit** or authorization **shall be required** from the Corps. You must apply separately to the Corps using their APPLICATION FOR DEPARTMENT OF THE ARMY PERMIT, ENG FORM 4345, or alternative as allowed by their regulations. More information on Corps permitting may be found online in the Jacksonville District Regulatory Division Source Book at: <https://www.saj.usace.army.mil/Missions/Regulatory/Source-Book>.

Authority for review - an agreement with the USACOE entitled "Coordination Agreement Between the U. S. Army Corps of Engineers (Jacksonville District) and the Florida Department of Environmental Protection (or Duly Authorized Designee), State Programmatic General Permit", Section 10 of the Rivers and Harbor Act of 1899, and Section 404 of the Clean Water Act.

#### Coastal Zone Management

Issuance of this authorization also constitutes a finding of consistency with Florida's Coastal Zone Management Program, as required by Section 307 of the Coastal Zone Management Act.

#### Water Quality Certification

This permit also constitutes a water quality certification under Section 401 of the Clean Water Act, 33 U.S.C. 1341.

#### Other Authorizations

You are advised that authorizations or permits for this activity may be required by other federal, state, regional, or local entities including but not limited to local governments or municipalities. This permit does not relieve you from the requirements to obtain all other required permits or authorizations.

The activity described may be conducted only in accordance with the terms, conditions and attachments contained in this document. Issuance and granting of the permit and authorizations herein do not infer, nor guarantee, nor imply that future permits, authorizations, or modifications will be granted by the Department.

### **PERMIT CONDITIONS**

The activities described must be conducted in accordance with:

- **The Specific Conditions**
- **The General Conditions**
- **The limits, conditions and locations of work shown in the attached drawings**
- **The term limits of this authorization**

You are advised to read and understand these conditions and drawings prior to beginning the authorized activities, and to ensure the work is conducted in conformance with all the terms, conditions, and drawings herein. If you are using a contractor, the contractor also should read and understand these conditions and drawings prior to beginning any activity. Failure to comply with these conditions, including any mitigation requirements, shall be grounds for the Department to revoke the permit and authorization and to take appropriate enforcement action. Operation of the facility is not authorized except when determined to be in conformance with all applicable rules and this permit authorization, as described.

### **SPECIFIC CONDITIONS**

1. Submittals required herein (e.g., progress reports, as-built drawings, etc.) shall include the permittee's name and permit number 41-0393941-001-EI and shall be directed by e-mail to [SW\\_ERP@floridadep.gov](mailto:SW_ERP@floridadep.gov) with a subject line of "Compliance: permit number 41-0393941-001-EI", or by mail to:

Department of Environmental Protection  
Southwest District  
ATTN: ERP Compliance Assurance  
13051 North Telecom Parkway, Suite 101  
Temple Terrace, FL 33637-0926

2. The structure/work authorized by this permit shall not be placed/conducted on any property, other than that owned by the permittee, without the prior written approval of that property owner.
3. In the event the permittee files for bankruptcy prior to completion of work permitted and required by this permit, the permittee must notify the Department within 30 days of filing. The notification shall identify the bankruptcy court and case number and shall include a copy of the bankruptcy petition.
4. This permit does not authorize the permittee to cause any adverse impact to or "take" of state listed species and other regulated species of fish and wildlife. Compliance with state laws regulating the take of fish and wildlife is the responsibility of the owner or applicant associated with this project. Please refer to Chapter 68A-27 of the Florida Administrative Code for definitions of "take" and a list of fish and wildlife species. If listed species are observed onsite, FWC staff are available to provide decision support information or assist in obtaining the appropriate FWC permits. Most marine endangered and threatened species are statutorily protected and a "take" permit cannot be issued. Requests for further information or review can be sent to [FWCConservationPlanningServices@MyFWC.com](mailto:FWCConservationPlanningServices@MyFWC.com).

### **SPECIFIC CONDITIONS – PRIOR TO ANY CONSTRUCTION**

5. Prior to placing any fill material in the seagrass restoration area, that has been obtained from a source other than Cemex Lake Wales Sand Mine or Jahna Independent South Mine, the permittee shall provide the Department with the source and technical specifications of the sediment fill material to be used. This shall include reasonable assurance that the sediment fill material is clean sand, and shall be free of excess silt, clay, organic material and toxic or deleterious substances/contaminants, and has a proportion of clay and silt which does not exceed that of the sediments currently within the project area. No more than 10% of the fill material shall pass through a #200 sieve. If more than 10% of the fill material passes through a #200 sieve, the Permittee shall meet with the Department to determine if further testing or project modifications are necessary, and the project may not commence without written authorization from the Department.

## **SPECIFIC CONDITIONS – CONSTRUCTION ACTIVITIES**

6. Wetland areas or waterbodies that are outside the specific limits of construction authorized by this permit, must be protected from erosion, sedimentation, siltation, scouring, excess turbidity, and/or dewatering. There shall be no discharge in violation of the water quality standards in Chapter 62 302, F.A.C. Turbidity/erosion controls shall be installed prior to clearing, excavation or placement of fill material, shall be maintained until construction is completed, disturbed areas are stabilized, and turbidity levels have fallen to less than ambient background. The turbidity and erosion control devices shall be removed within 14 days once these conditions are met.
7. Areas of exposed soils shall be isolated from wetlands or other surface waters to prevent erosion and deposition of these soils into wetlands or other surface waters during construction and operation of permitted activities.
8. The permittee shall be responsible for ensuring erosion control devices/procedures are inspected and maintained daily during all phases of construction authorized by this permit until areas disturbed during construction are sufficiently stabilized to prevent erosion, siltation, and turbid discharges.
9. A floating turbidity apron/curtain shall be installed around the waterward boundary of the construction area prior to construction and shall remain in place until construction is complete and turbidity levels within the work area have returned to background levels.
10. Turbidity levels outside the construction area shall not exceed ambient levels within the Outstanding Florida Waterbody. The following measures shall be taken immediately by the permittee whenever turbidity levels within waters of the State surrounding the project site exceed ambient levels within the Outstanding Florida Waterbody:
  - a. Notify the Department at 813-470-5700 at the time the violation is first detected.
  - b. Immediately cease all work contributing to the water quality violation.
  - c. Modify the work procedures that were responsible for the violation, install more turbidity containment devices, and repair any non-functional turbidity containment devices.
  - d. As required, perform turbidity monitoring per Specific Conditions 11 and 12.
  - e. Resume construction activities once turbidity levels outside turbidity curtains fall below ambient levels within the Outstanding Florida Waterbody.
11. Water turbidity levels shall be monitored if a turbidity plume is observed outside the limits of the required turbidity control devices. Samples shall be taken every four hours, one foot above the bottom, mid-depth, and one-foot below the surface at monitoring stations located as follows:
  - a. Approximately 100 feet up-current of the work sites and clearly outside the influence of construction activities. (This shall serve as the natural background sample against which other turbidity readings shall be compared.)
  - b. Directly outside the turbidity curtains surrounding the work sites and within the densest portion of any visible turbidity plume. (This sample shall serve as the compliance sample.)
  - c. Unauthorized impacts to wetlands as a result of the authorized construction shall be reported to the Department within 24 hours.
12. Storage or stockpiling of tools and materials (i.e., lumber, pilings, debris) within wetlands or other surface waters is prohibited.
13. The permittee shall ensure that no seagrass is dredged or impacted outside the limits of construction areas and restoration areas shown and authorized on the attached exhibits.

14. If dredged material encroaches into adjacent waters of the state beyond the construction site limits identified in the attached permit drawings, the impacted areas shall be restored to their original contours and elevations. If the impacted areas were vegetated, they shall be replanted after recontouring, with vegetation of appropriate size and densities and species as is present in the adjacent areas. The restoration shall be completed within 30 days of completion of the dredging operation and the Department shall be so notified within the same 30-day period. Appropriate turbidity control measures shall be followed during the restoration work.
15. All in-water fill shall be contained within appropriate best management practices to prevent sedimentation or turbid discharges due to the escape of fill material.

#### **SPECIFIC CONDITIONS – MITIGATION**

16. The Permittee shall implement and complete all mitigation activities as identified in the Mitigation Plan document attached within this permit.
17. To mitigate for permanent impacts to 0.17 acres of freshwater marsh (FLUCCS 641), 0.79 acres of mangroves (FLUCCS 612), 1.91 acres of seagrass (*Halodule wrightii* and *Thalassia testudinum*) (FLUCCS 645), and 0.11 acres of oyster bars (FLUCCS 654), the permittee shall implement the mitigation plan as described in the Mitigation Plan document (attached) within 30 days of permit issuance. The plan shall consist of:
  - a. the restoration of 0.17 acres of freshwater marsh wetlands.
  - b. the restoration of 1.18 acres of mangrove habitat.
  - c. the restoration/enhancement of 8.64 acres of seagrass area.
  - d. the relocation/enhancement of 0.22 acres of oyster beds.
18. The Department's approval of the mitigation plan pursuant to this permit does not constitute a finding by the Department the mitigation will meet the required success criteria. The permittee acknowledges its obligation to meet the intent of the permit regarding the mitigation objective until the mitigation is determined by the Department to be successful.

#### **SPECIFIC CONDITIONS – MONITORING/REPORTING REQUIREMENTS**

##### **Mangroves and Freshwater Marsh wetlands**

19. A "Time Zero" Monitoring Report shall be submitted within 30 days of completion of planting the freshwater marsh wetland and mangrove areas and shall include the following:
  - a. Date the planting was completed;
  - b. Color photographs that provide an accurate representation of the planted areas. The photographs shall be numbered and correspond to their respective locations, shown on an associated map.
  - c. Condition of the substrate and submerged aquatic vegetation (SAV).
20. Subsequent mitigation monitoring reports shall be submitted for 3 years (semi-annually the first year, and annually for the second and the third year) and begin one year from the "Time Zero Monitoring Report". The Monitoring reports shall include the following for each mitigation area:
  - a. Color photographic prints taken from the reference points established in the Time Zero Monitoring Report.
  - b. Detailed description of statistical methods used which must include the following:

- i. Subsample method and map of sampling locations
    - ii. Method used to determine percent cover and growth
    - iii. Statistical analyses used to determine valid subsample size and to analyze results of sampling
  - c. Total percent cover by planted species.
  - d. Plant species composition with estimates of the contribution of each species to percent cover.
  - e. Plan view depicting the locations of specimens replanted. (Indicate numbers of each species replanted).
  - f. Growth data for mangrove species. Data shall include measurements of height, diameter, at breast height (dbh) and mean annual growth rate to date.
  - g. % Canopy coverage of mangrove species.
  - h. Data documenting the hydrologic regime (seasonal high and normal pool; ordinary high; or mean high and low water elevations).
  - i. Description of the pertinent climatological conditions preceding the monitoring event.
  - j. Description of the soil moisture condition in the mitigation area(s), i.e., soil appears dry, saturated with water or with so many inches of standing water.
  - k. Photocopy of the field notes depicting the raw data collected.
21. The mitigation shall be deemed successful when the below criteria have been continuously met for a period of at least one (1) year, without intervention in the form of irrigation, removal of undesirable vegetation, or replanting of desirable vegetation.
  - a. Planted herbaceous species and naturally recruited wetland species have achieved a minimum 90% cover.
  - b. Planted mangrove species have achieved a minimum 90% survival and exhibit vigorous growth characteristics consistent with the species
  - c. Total contribution to percent cover by non-native wetland species and species not listed in 62-340.450, F.A.C. shall be maintained below 10%.
  - d. The Department's State Lands and Environmental Resource Program staff has inspected the mitigation area and determined that the mitigation area(s) meet the above success criteria.

### **Seagrass Restoration Area**

22. Subsequent Monitoring Reports for seagrass restoration areas shall be submitted annually for five years, beginning one year from the date of the "Time Zero" Monitoring Report, and shall include the following:
  - a. Date the annual assessment was conducted.
  - b. Color photographs that provide an accurate representation of the planted areas. The photographs shall be numbered and correspond to their respective locations, shown on an associated map.
  - c. Total percent cover by any planted species.
  - d. Plant species composition with estimates of the contribution of each species to percent cover.
  - e. Description of the pertinent climatological conditions preceding the monitoring event.
23. The seagrass restoration areas shall be deemed successful when the below criteria have been continuously met for a period of at least one (1) year, without intervention in the form of removal of undesirable vegetation or replanting of desirable vegetation:
  - a. The restoration areas identified in the Mitigation Plan (attached) have become established with greater than 75% coverage of seagrass.

- b. Total contribution to percent cover by non-native wetland species and species not listed in 62-340.450, F.A.C. shall be maintained below 5%.
- c. The Department's State Lands and Environmental Resource Program staff has inspected the seagrass creation areas and determined that the project meets the above success criteria.

### **All Mitigation Areas**

- 24. The responsibility to assess if the creation areas are meeting the permit-specified success criteria shall not fall solely on the Department. In the event the permittee becomes aware the project is not meeting the success criteria (based on either site observations or review of monitoring reports), the permittee, no later than six months before the permit construction phase expiration date, shall submit an alternative habitat creation plan to the Department for review and approval.
- 25. The permittee shall implement the alternative plan no later than 60 days after receiving Department approval.
- 26. Failure of the Department to notify the permittee of project failure does not prevent the Department from requiring the permittee to meet the success criteria as defined in Specific Condition Nos. 21 and 23.

### **SPECIFIC CONDITIONS – MANATEES**

- 27. All personnel associated with the project shall be instructed about the presence of manatees and manatee speed zones, and the need to avoid collisions with, and injury to manatees. The permittee shall advise all construction personnel that there are civil and criminal penalties for harming, harassing, or killing manatees which are protected under the Marine Mammal Protection Act, the Endangered Species Act, and the Florida Manatee Sanctuary Act.
- 28. All vessels associated with the construction project shall operate at "Idle Speed/No Wake" at all times while in the immediate area and while in water where the draft of the vessel provides less than a four-foot clearance from the bottom. All vessels shall follow routes of deep water whenever possible.
- 29. No nighttime mechanical dredging, such as clamshell, shall occur.
- 30. Siltation or turbidity barriers shall be made of material in which manatees cannot become entangled, shall be properly secured, and shall be regularly monitored to avoid manatee entanglement or entrapment. Barriers shall not impede manatee movement.
- 31. All on-site project personnel are responsible for observing water-related activities for the presence of manatees. All in-water operations, including vessels, shall be shutdown if a manatee comes within 50 feet of the operation. Activities shall not resume until every manatee has moved beyond the 50-foot radius of the project operation, or until 30 minutes has elapsed wherein a manatee has not reappeared within 50 feet of the operation. Animals shall not be herded away or harassed into leaving.
- 32. Any collision with or injury to a manatee shall be reported immediately to the FWC Hotline at 1-888-404-FWCC. Collision and/or injury should also be reported to the U.S. Fish and Wildlife Service in Jacksonville (1-904-731-3336) for north Florida or Vero Beach (1-772-562-3909) for south Florida.

**SPECIFIC CONDITIONS – OTHER LISTED SPECIES**

- 33. This permit does not authorize the permittee to cause any adverse impact to or “take” of state listed species and other regulated species of fish and wildlife. Compliance with state laws regulating the take of fish and wildlife is the responsibility of the owner or applicant associated with this project. Please refer to Chapter 68A-27 of the Florida Administrative Code for definitions of “take” and a list of fish and wildlife species. If listed species are observed onsite, FWC staff are available to provide decision support information or assist in obtaining the appropriate FWC permits. Most marine endangered and threatened species are statutorily protected and a “take” permit cannot be issued. Requests for further information or review can be sent to [FWCConservationPlanningServices@MyFWC.com](mailto:FWCConservationPlanningServices@MyFWC.com).

**SPECIFIC CONDITIONS – CONSTRUCTION COMPLETION**

The permittee shall comply with the following conditions prior to the transfer to operation phase of the facility. All documentation required below shall be included with the permittee’s request to transfer the project to the operation phase [Form No. 62-330.310(2), F.A.C.].

- 34. The permittee shall submit one set of signed, dated and sealed as-built drawings to the Department via email at [SW\\_ERP@dep.state.fl.us](mailto:SW_ERP@dep.state.fl.us) for review and approval within 30 days of completion of construction. (Please contact the Department for files that are too large to email for alternative means of submitting electronically.) The as-built drawings shall be based on the Department permitted construction drawings and any pertinent specific conditions, which should be revised to reflect changes made during construction. Both the original design and constructed elevations must be clearly shown. The plans must be clearly labeled as "as-built" or "record" drawings. Surveyed dimensions and elevations required shall be verified and signed, dated and sealed by a Florida registered professional. *As-builts shall be submitted to the Department regardless of whether or not deviations are present.*

The following information shall be verified on the as-built drawing from the engineering drawings signed and sealed by Matthew S. Richards, P.E., #71505, on December 17, 2021.

Plan View/ Cross Section Name	Drawing Number
Cable Installation Plan and Cross-sections	Pages 2-15

**GENERAL CONDITIONS FOR INDIVIDUAL PERMITS**

The following general conditions are binding on all individual permits issued under chapter 62-330, F.A.C., except where the conditions are not applicable to the authorized activity, or where the conditions must be modified to accommodate project-specific conditions.

- 1. All activities shall be implemented following the plans, specifications and performance criteria approved by this permit. Any deviations must be authorized in a permit modification in accordance with Rule 62-330.315, F.A.C. Any deviations that are not so authorized may subject the permittee to enforcement action and revocation of the permit under Chapter 373, F.S.
- 2. A complete copy of this permit shall be kept at the work site of the permitted activity during the construction phase, and shall be available for review at the work site upon request by the Agency staff. The permittee shall require the contractor to review the complete permit prior to beginning construction.



3. Activities shall be conducted in a manner that does not cause or contribute to violations of state water quality standards. Performance-based erosion and sediment control best management practices shall be installed immediately prior to, and be maintained during and after construction as needed, to prevent adverse impacts to the water resources and adjacent lands. Such practices shall be in accordance with the *State of Florida Erosion and Sediment Control Designer and Reviewer Manual (Florida Department of Environmental Protection and Florida Department of Transportation June 2007)*, and the *Florida Stormwater Erosion and Sedimentation Control Inspector's Manual (Florida Department of Environmental Protection, Nonpoint Source Management Section, Tallahassee, Florida, July 2008)*, which are both incorporated by reference in subparagraph 62-330.050(9)(b)5., F.A.C., unless a project-specific erosion and sediment control plan is approved or other water quality control measures are required as part of the permit.
4. At least 48 hours prior to beginning the authorized activities, the permittee shall submit to the Agency a fully executed Form 62-330.350(1), "Construction Commencement Notice," [October 1, 2013], which is incorporated by reference [in](#) paragraph 62-330.350(1)(d), F.A.C., indicating the expected start and completion dates. A copy of this form may be obtained from the Agency, as described in subsection 62-330.010(5), F.A.C. If available, an Agency website that fulfills this notification requirement may be used in lieu of the form.
5. Unless the permit is transferred under Rule 62-330.340, F.A.C., or transferred to an operating entity under Rule 62-330.310, F.A.C., the permittee is liable to comply with the plans, terms and conditions of the permit for the life of the project or activity.
6. Within 30 days after completing construction of the entire project, or any independent portion of the project, the permittee shall provide the following to the Agency, as applicable:
  - a. For an individual, private single-family residential dwelling unit, duplex, triplex, or quadruplex – "Construction Completion and Inspection Certification for Activities Associated With a Private Single-Family Dwelling Unit" [Form 62-330.310(3)]; or
  - b. For all other activities – "As-Built Certification and Request for Conversion to Operational Phase" [Form 62-330.310(1)].
  - c. If available, an Agency website that fulfills this certification requirement may be used in lieu of the form.
7. If the final operation and maintenance entity is a third party:
  - a. Prior to sales of any lot or unit served by the activity and within one year of permit issuance, or within 30 days of as- built certification, whichever comes first, the permittee shall submit, as applicable, a copy of the operation and maintenance documents (see sections 12.3 thru 12.3.3 of Volume I) as filed with the Department of State, Division of Corporations and a copy of any easement, plat, or deed restriction needed to operate or maintain the project, as recorded with the Clerk of the Court in the County in which the activity is located.
  - b. Within 30 days of submittal of the as- built certification, the permittee shall submit "Request for Transfer of Environmental Resource Permit to the Perpetual Operation Entity" [Form 62-330.310(2)] to transfer the permit to the operation and maintenance entity, along with the

- documentation requested in the form. If available, an Agency website that fulfills this transfer requirement may be used in lieu of the form.
8. The permittee shall notify the Agency in writing of changes required by any other regulatory agency that require changes to the permitted activity, and any required modification of this permit must be obtained prior to implementing the changes.
  9. This permit does not:
    - a. Convey to the permittee any property rights or privileges, or any other rights or privileges other than those specified herein or in Chapter 62-330, F.A.C.;
    - b. Convey to the permittee or create in the permittee any interest in real property;
    - c. Relieve the permittee from the need to obtain and comply with any other required federal, state, and local authorization, law, rule, or ordinance; or
    - d. Authorize any entrance upon or work on property that is not owned, held in easement, or controlled by the permittee.
  10. Prior to conducting any activities on state-owned submerged lands or other lands of the state, title to which is vested in the Board of Trustees of the Internal Improvement Trust Fund, the permittee must receive all necessary approvals and authorizations under Chapters 253 and 258, F.S. Written authorization that requires formal execution by the Board of Trustees of the Internal Improvement Trust Fund shall not be considered received until it has been fully executed.
  11. The permittee shall hold and save the Agency harmless from any and all damages, claims, or liabilities that may arise by reason of the construction, alteration, operation, maintenance, removal, abandonment or use of any project authorized by the permit.
  12. The permittee shall notify the Agency in writing:
    - a. Immediately if any previously submitted information is discovered to be inaccurate; and
    - b. Within 30 days of any conveyance or division of ownership or control of the property or the system, other than conveyance via a long-term lease, and the new owner shall request transfer of the permit in accordance with Rule 62-330.340, F.A.C. This does not apply to the sale of lots or units in residential or commercial subdivisions or condominiums where the stormwater management system has been completed and converted to the operation phase.
  13. Upon reasonable notice to the permittee, Agency staff with proper identification shall have permission to enter, inspect, sample and test the project or activities to ensure conformity with the plans and specifications authorized in the permit.
  14. If any prehistoric or historic artifacts, such as pottery or ceramics, stone tools or metal implements, dugout canoes, or any other physical remains that could be associated with Native American cultures, or early colonial or American settlement are encountered at any time within the project site area, work involving subsurface disturbance in the immediate vicinity of such discoveries shall cease. The permittee or other designee shall contact the Florida Department of State, Division of Historical Resources, Compliance and Review Section, at (850) 245-6333 or (800) 847-7278, as well

- as the appropriate permitting agency office. Such subsurface work shall not resume without verbal or written authorization from the Division of Historical Resources. If unmarked human remains are encountered, all work shall stop immediately and notification shall be provided in accordance with Section 872.05, F.S.
15. Any delineation of the extent of a wetland or other surface water submitted as part of the permit application, including plans or other supporting documentation, shall not be considered binding unless a specific condition of this permit or a formal determination under Rule 62-330.201, F.A.C., provides otherwise.
  16. The permittee shall provide routine maintenance of all components of the stormwater management system to remove trapped sediments and debris. Removed materials shall be disposed of in a landfill or other uplands in a manner that does not require a permit under Chapter 62-330, F.A.C., or cause violations of state water quality standards.
  17. This permit is issued based on the applicant's submitted information that reasonably demonstrates that adverse water resource-related impacts will not be caused by the completed permit activity. If any adverse impacts result, the Agency will require the permittee to eliminate the cause, obtain any necessary permit modification, and take any necessary corrective actions to resolve the adverse impacts.
  18. A Recorded Notice of Environmental Resource Permit may be recorded in the county public records in accordance with subsection 62-330.090(7), F.A.C. Such notice is not an encumbrance upon the property.

## **NOTICE OF RIGHTS**

This action is final and effective on the date filed with the Clerk of the Department unless a petition for an administrative hearing is timely filed under Sections 120.569 and 120.57, F.S., before the deadline for filing a petition. On the filing of a timely and sufficient petition, this action will not be final and effective until further order of the Department. Because the administrative hearing process is designed to formulate final agency action, the hearing process may result in a modification of the agency action or even denial of the application.

### Petition for Administrative Hearing

A person whose substantial interests are affected by the Department's action may petition for an administrative proceeding (hearing) under Sections 120.569 and 120.57, F.S. Pursuant to Rule 28-106.201, F.A.C., a petition for an administrative hearing must contain the following information:

- (a) The name and address of each agency affected and each agency's file or identification number, if known;
- (b) The name, address, any email address, any facsimile number, and telephone number of the petitioner; the name, address, and telephone number of the petitioner's representative, if any, which shall be the address for service purposes during the course of the proceeding; and an explanation of how the petitioner's substantial interests are or will be affected by the agency determination;
- (c) A statement of when and how the petitioner received notice of the agency decision;
- (d) A statement of all disputed issues of material fact. If there are none, the petition must so indicate;
- (e) A concise statement of the ultimate facts alleged, including the specific facts that the petitioner contends warrant reversal or modification of the agency's proposed action;

- (f) A statement of the specific rules or statutes that the petitioner contends require reversal or modification of the agency's proposed action, including an explanation of how the alleged facts relate to the specific rules or statutes; and
- (g) A statement of the relief sought by the petitioner, stating precisely the action that the petitioner wishes the agency to take with respect to the agency's proposed action.

The petition must be filed (received by the Clerk) in the Office of General Counsel of the Department at 3900 Commonwealth Boulevard, Mail Station 35, Tallahassee, Florida 32399-3000. Also, a copy of the petition shall be mailed to the applicant at the address indicated above at the time of filing.

#### Time Period for Filing a Petition

In accordance with Rule 62-110.106(3), F.A.C., petitions for an administrative hearing by the applicant must be filed within 14 days of receipt of this written notice. Petitions filed by any persons other than the applicant, and other than those entitled to written notice under Section 120.60(3), F.S., must be filed within 14 days of publication of the notice or within 14 days of receipt of the written notice, whichever occurs first. Under Section 120.60(3), F.S., however, any person who has asked the Department for notice of agency action may file a petition within 14 days of receipt of such notice, regardless of the date of publication. The failure to file a petition within the appropriate time period shall constitute a waiver of that person's right to request an administrative determination (hearing) under Sections 120.569 and 120.57, F.S., or to intervene in this proceeding and participate as a party to it. Any subsequent intervention (in a proceeding initiated by another party) will be only at the discretion of the presiding officer upon the filing of a motion in compliance with Rule 28-106.205, F.A.C.

#### Extension of Time

Under Rule 62-110.106(4), F.A.C., a person whose substantial interests are affected by the Department's action may also request an extension of time to file a petition for an administrative hearing. The Department may, for good cause shown, grant the request for an extension of time. Requests for extension of time must be filed with the Office of General Counsel of the Department at 3900 Commonwealth Boulevard, Mail Station 35, Tallahassee, Florida 32399-3000, before the applicable deadline for filing a petition for an administrative hearing. A timely request for extension of time shall toll the running of the time period for filing a petition until the request is acted upon.

#### Mediation

Mediation is not available in this proceeding.

#### FLAWAC Review

The applicant, or any party within the meaning of Section 373.114(1)(a) or 373.4275, F.S., may also seek appellate review of this order before the Land and Water Adjudicatory Commission under Section 373.114(1) or 373.4275, F.S. Requests for review before the Land and Water Adjudicatory Commission must be filed with the Secretary of the Commission and served on the Department within 20 days from the date when this order is filed with the Clerk of the Department.

#### Judicial Review

Once this decision becomes final, any party to this action has the right to seek judicial review pursuant to Section 120.68, F.S., by filing a Notice of Appeal pursuant to Rules 9.110 and 9.190, Florida Rules of Appellate Procedure, with the Clerk of the Department in the Office of General Counsel, 3900 Commonwealth Boulevard, M.S. 35, Tallahassee, Florida 32399-3000; and by filing a copy of the Notice of Appeal accompanied by the applicable filing fees with the appropriate District Court of Appeal. The Notice of Appeal must be filed within 30 days from the date this action is filed with the Clerk of the Department.

Executed in Hillsborough County, Florida.

STATE OF FLORIDA DEPARTMENT  
OF ENVIRONMENTAL PROTECTION



Michael Lynch  
Permitting Program Administrator  
Permitting & Waste Cleanup Programs  
Southwest District

**Attachments:**

1. Project Drawings and Design Specs., 17 pages
2. Mitigation Plan document, 33 pages
3. Mitigation Plan drawings, 17 pages
4. Construction Commencement Notice/Form 62-330.350(1), 1 page
5. Operation and Maintenance Inspection Certification, 2 pages
6. As-built Certification and Request for Conversion to Operational Phase/ Form 62-330.310(1), 3 pages
7. Request for Transfer of ERP to the Perpetual Operation Entity, 1 page
8. Request to Transfer Permit, 2 pages

**Copies furnished to:**

Carla Burrmann, Southwest District, [carla.burrmann@floridadep.gov](mailto:carla.burrmann@floridadep.gov)  
Michael Lynch, FDEP, [Michael.Lynch@floridadep.gov](mailto:Michael.Lynch@floridadep.gov)  
ERP Permitting, Southwest District, [sw\\_erp@floridadep.gov](mailto:sw_erp@floridadep.gov)  
U.S. Army Corps of Engineers, [tampareg@usace.army.mil](mailto:tampareg@usace.army.mil)  
Ricardo Borromeo, Carollo Engineers, [rborromeo@carollo.com](mailto:rborromeo@carollo.com)  
Doug Robison, ESA, [drobison@esassoc.com](mailto:drobison@esassoc.com)

**CERTIFICATE OF SERVICE**

The undersigned hereby certifies that this permit, including all copies, were mailed before the close of business on January 27, 2022, to the above listed persons.

**FILING AND ACKNOWLEDGMENT**

FILED, on this date, under 120.52(7) of the Florida Statutes, with the designated Department Clerk, receipt of which is hereby acknowledged.



Clerk

January 27, 2022

Date



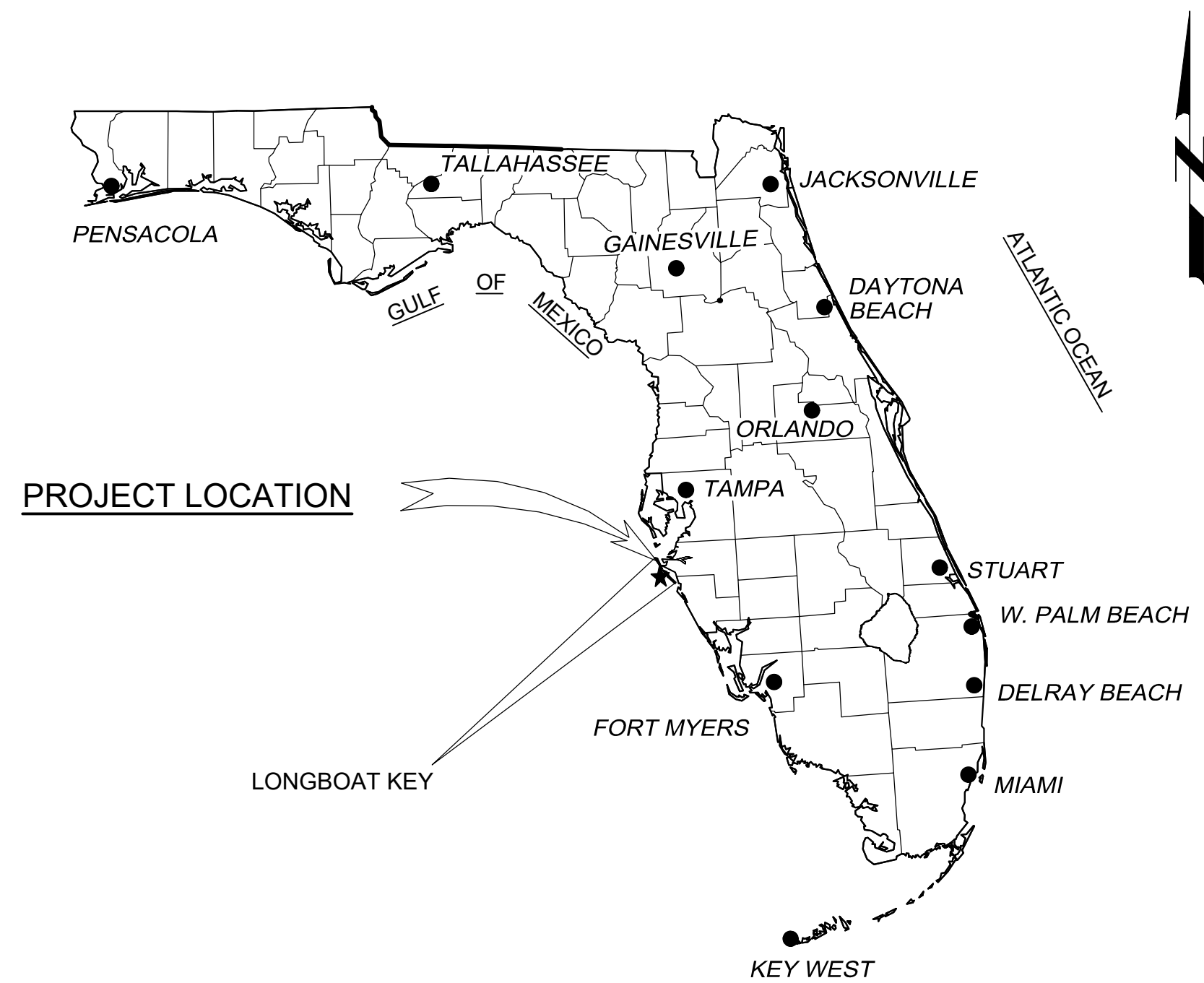
# TOWN OF LONGBOAT KEY

## ENVIRONMENTAL PERMITTING FOR SUBAQUEOUS FORCEMAIN

### PERMIT PLANS - NOT FOR CONSTRUCTION

**SHEET INDEX**

SHEET	DWG	DESCRIPTION
<b>GENERAL</b>		
1	G01	COVER SHEET
<b>CIVIL</b>		
2	C01	PLAN AND PROFILE STA 19+00 TO 29+00
3	C02	PLAN AND PROFILE STA 29+00 TO 39+00
4	C03	PLAN AND PROFILE STA 39+00 TO 49+00
5	C04	PLAN AND PROFILE STA 49+00 TO 59+00
6	C05	PLAN AND PROFILE STA 59+00 TO 69+00
7	C06	PLAN AND PROFILE STA 69+00 TO 79+00
8	C07	PLAN AND PROFILE STA 79+00 TO 89+00
9	C08	PLAN AND PROFILE STA 89+00 TO 99+00
10	C09	PLAN AND PROFILE STA 99+00 TO 109+00
11	C10	PLAN AND PROFILE STA 109+00 TO 119+00
12	C11	PLAN AND PROFILE STA 119+00 TO 129+00
13	C12	PLAN AND PROFILE STA 129+00 TO 138+34±
14	CD1	SECTIONS 1
15	CD2	SECTIONS 2



**PROJECT LOCATION**

**LOCATION MAP**  
NOT TO SCALE

LONGBOAT KEY COMMISSION	
TOWN COMMISSIONER DISTRICT 1	SHERRY DOMINICK
TOWN COMMISSIONER DISTRICT 2	GEORGE SPOLL
MAYOR AND TOWN COMMISSIONER DISTRICT 3	KEN SCHNEIER
TOWN COMMISSIONER DISTRICT 4	JACK DALY
TOWN COMMISSIONER DISTRICT 5	ED ZUNZ
TOWN COMMISSIONER AT LARGE	B. J. BISHOP
VICE-MAYOR AND TOWN COMMISSIONER AT LARGE	MIKE HANCOCK

**ACCEPTED BY:**

ISAAC BROWNMAN, PUBLIC WORKS AND UTILITIES DIRECTOR      DATE \_\_\_\_\_

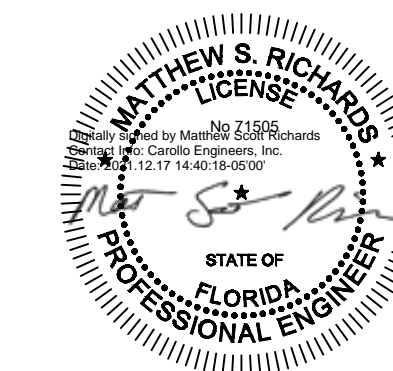
**TIDE DATUM TABLE**

1. TIDAL DATUM TABLE OBTAINED FROM THE WHITFIELD ESTATES, SARASOTA BAY TIDE STATION, STATION NO 8726159

DATUM	ELEVATION (FT NAVD88)
MHHW	+0.41
MHW	+0.13
MSL	-0.50
MTL	-0.52
MLW	-1.16
MLLW	-1.69



401 N. CATTLEMEN RD., SUITE 306  
SARASOTA, FL. 34232  
PHONE: (941)371-9832  
FAX: (941)371-9873  
CA 00008571



DECEMBER 2021

JOB NO.	11006H.10
DRAWING NO.	G01
SHEET NO.	1 OF 15

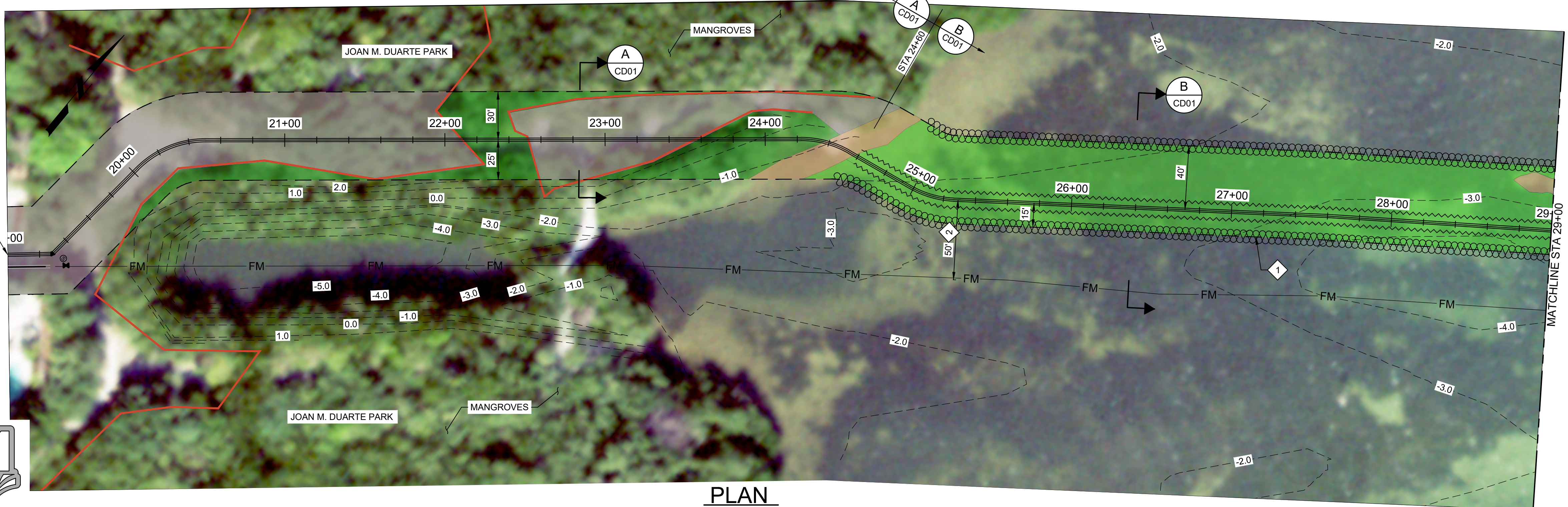


Plot Date: 12/16/2021 1:50:45 PM

FILE NAME: 11006H10C001.dwg

PROJECT NO.: 11006H10

LAST SAVED BY: bhwaves



- GENERAL NOTES:**
- 50' FROM CL OF NEW 20" ID HDPE FORCE MAIN (FM) PIPE TO EXISTING 20" DIP FORCE MAIN.
  - EXISTING 20" DIP FM SHOWN IN PROFILE AS REFERENCE ONLY.
  - THE EXISTING FORCE MAIN IS TO REMAIN IN PLACE FOR FUTURE CONDITION ASSESSMENT AND POTENTIAL REHABILITATION. AFTER REHABILITATION, EXISTING FORCE MAIN MAY BE USED AS A REDUNDANT FORCE MAIN OR FOR BRINGING RECLAIMED WATER TO THE TOWN.

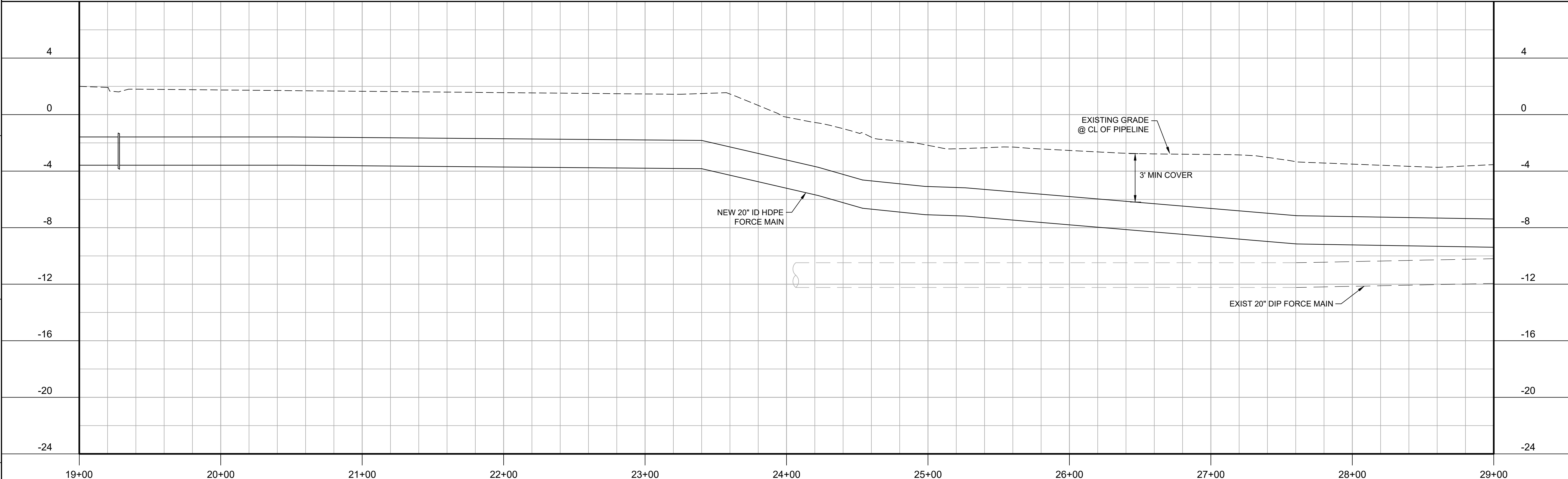
- KEY NOTES:**
- THIS DIMENSION IS APPROXIMATE DUE TO THE VARIANCE OF THE EXISTING FORCE MAIN.

**LEGEND**

- FM — EXISTING FORCE MAIN
- ===== PROPOSED FORCE MAIN
- - - - CONSTRUCTION LIMITS
- LIMITS OF JURISDICTIONAL WETLANDS
- ~ ~ ~ ~ SHEET PILE
- ⊗ ⊗ ⊗ ⊗ TURBIDITY CURTAIN
- NON-VEGETATED BAY BOTTOM
- PATCHY SEAGRASS
- CONTINUOUS SEAGRASS
- OYSTERS
- INTERTIDAL WETLAND (MANGROVES)
- FRESHWATER WETLAND
- UPLANDS
- SEAGRASS RESTORATION FILL AREAS
- RIPRAP



Know what's below.  
Call before you dig.



**KEY MAP**

**SCALE**

0 20' 40' 80'  
SCALE: 1" = 40' (HORIZ)

0 5' 10' 20'  
SCALE: 1" = 10' (VERT)

KEY MAP NORTH

**PERMIT PLANS NOT FOR CONSTRUCTION**

REV	DATE	BY	DESCRIPTION
1			
2			

DESIGNED MAF  
DRAWN BWH  
CHECKED SR  
DATE DECEMBER 2021

**MATTHEW S. RICHARDS**  
LICENSE No 71505  
STATE OF FLORIDA PROFESSIONAL ENGINEER

Digitally signed by Matthew Scott Richards  
Contact Info: Carollo Engineers, Inc.  
Date: 2021.12.17 14:12:00-0500

*Matthew Scott Richards*



TOWN OF LONGBOAT KEY  
ENVIRONMENTAL PERMITTING FOR  
SUBAQUEOUS FORCE MAIN  
CIVIL  
**PLAN AND PROFILE**  
STA 19+00 TO 29+00

**VERIFY SCALES**

BAR IS ONE INCH ON ORIGINAL DRAWING

0 1" 1"

IF NOT ONE INCH ON THIS SHEET, ADJUST SCALES ACCORDINGLY

JOB NO. 11006H.10
DRAWING NO. <b>C01</b>
SHEET NO. 2 OF 15

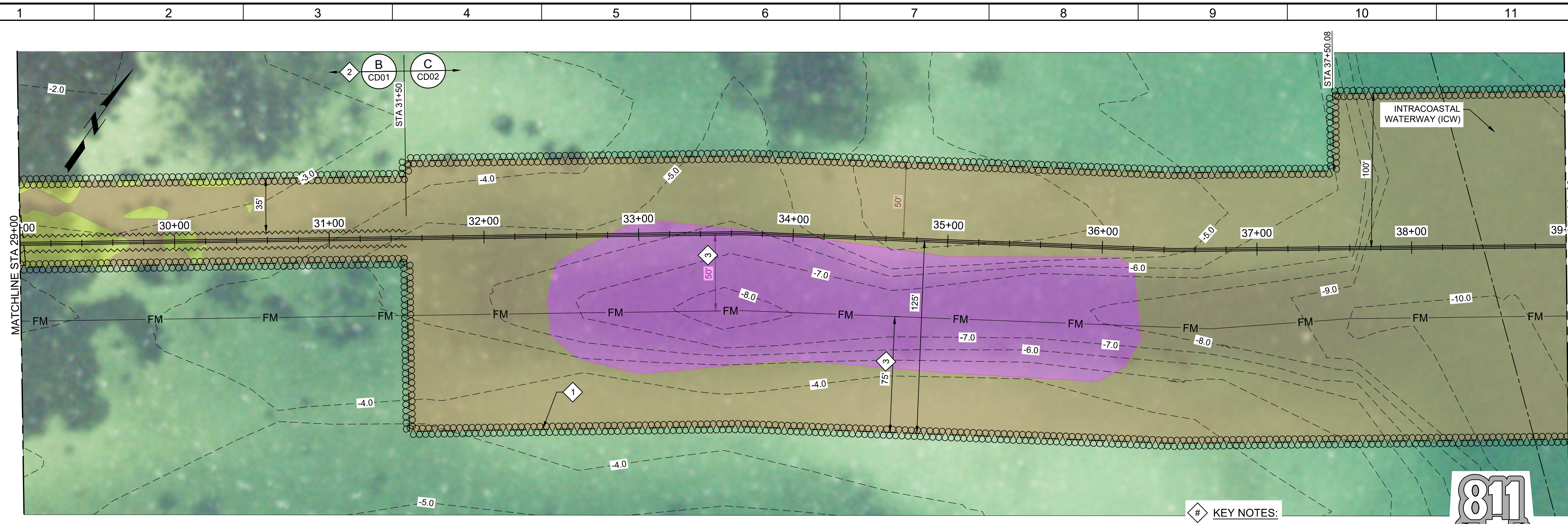


Plot Date: 12/16/2021 1:52:48 PM

FILE NAME: 11006H10C02.dwg

PROJECT NO.: 11006H10

LAST SAVED BY: bhawes



**PLAN**  
FILE: 11006H1001C100

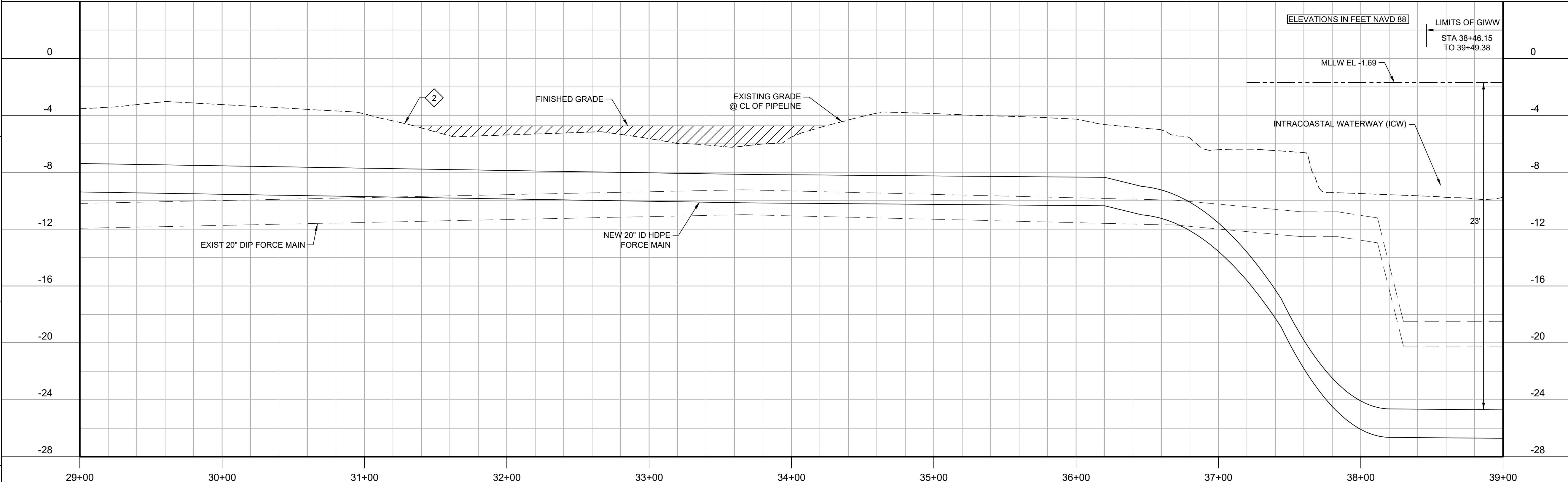
**KEY NOTES:**

1. SOUTH CONSTRUCTION LIMIT.
2. BARGE LIMIT SITTING ON EXISTING GRADE.
3. THIS DIMENSION IS APPROXIMATE DUE TO THE VARIANCE OF THE EXISTING FORCE MAIN.

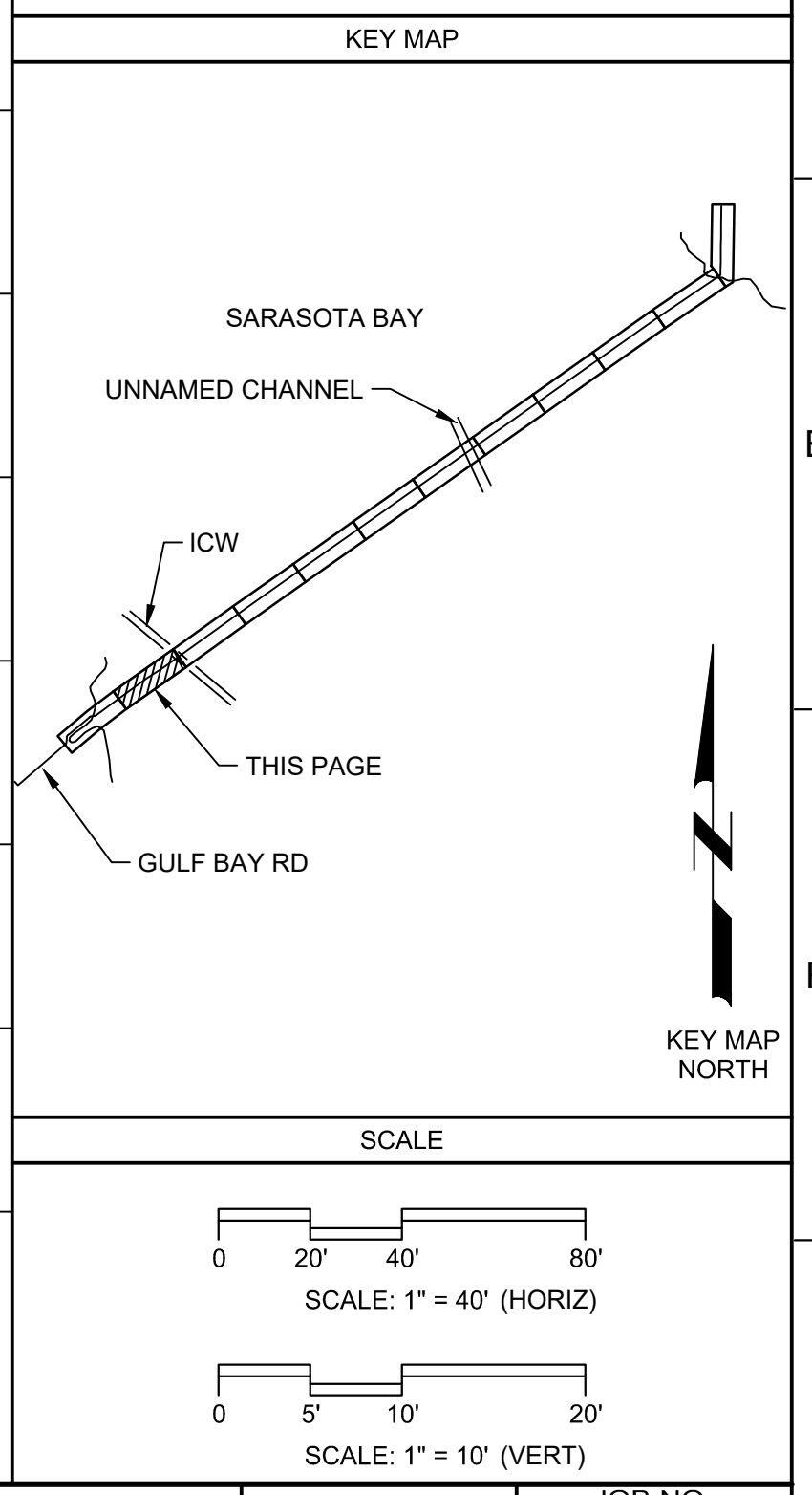
**Know what's below.  
Call before you dig.**

- GENERAL NOTES:**
1. 50' FROM CL OF NEW 20" ID HDPE FORCE MAIN (FM) PIPE TO EXISTING 20" DIP FORCE MAIN.
  2. EXISTING 20" DIP FM SHOWN IN PROFILE AS REFERENCE ONLY.
  3. THE EXISTING FORCE MAIN IS TO REMAIN IN PLACE FOR FUTURE CONDITION ASSESSMENT AND POTENTIAL REHABILITATION. AFTER REHABILITATION, EXISTING FORCE MAIN MAY BE USED AS A REDUNDANT FORCE MAIN OR FOR BRINGING RECLAIMED WATER TO THE TOWN.
  4. BACKFILLING SHOULD BE DONE CAREFULLY SO AS NOT TO CAUSE ANY SHOALING OF THE GULF INTERCOASTAL WATERWAY (GIWW) NAVIGATION CHANNEL.
  5. DEPTH OF PROPOSED FM SHALL BE AT -24 FOR THE FULL WIDTH OF THE GIWW PLUS 25 FEET ON EITHER SIDE, FOR A TOTAL OF 150 FEET.

- LEGEND**
- FM EXISTING FORCE MAIN
  - PROPOSED FORCE MAIN
  - CONSTRUCTION LIMITS
  - LIMITS OF JURISDICTIONAL WETLANDS
  - SHEET PILE
  - TURBIDITY CURTAIN
  - NON-VEGETATED BAY BOTTOM
  - PATCHY SEAGRASS
  - CONTINUOUS SEAGRASS
  - OYSTERS
  - INTERTIDAL WETLAND (MANGROVES)
  - FRESHWATER WETLAND
  - UPLANDS
  - SEAGRASS RESTORATION FILL AREAS
  - RIPRAP



**PROFILE**  
FILE: 11006H1001C100



**PERMIT PLANS  
NOT FOR CONSTRUCTION**

REV	DATE	BY	DESCRIPTION
1			
2			
3			

DESIGNED MAF  
DRAWN BWH  
CHECKED SR  
DATE DECEMBER 2021

**MATTHEW S. RICHARDS**  
No. 71505  
STATE OF FLORIDA  
PROFESSIONAL ENGINEER

Digitally signed by Matthew Scott Richards  
Contact Info: Carollo Engineers, Inc.  
Date: 2021.12.17 14:50:58-0500

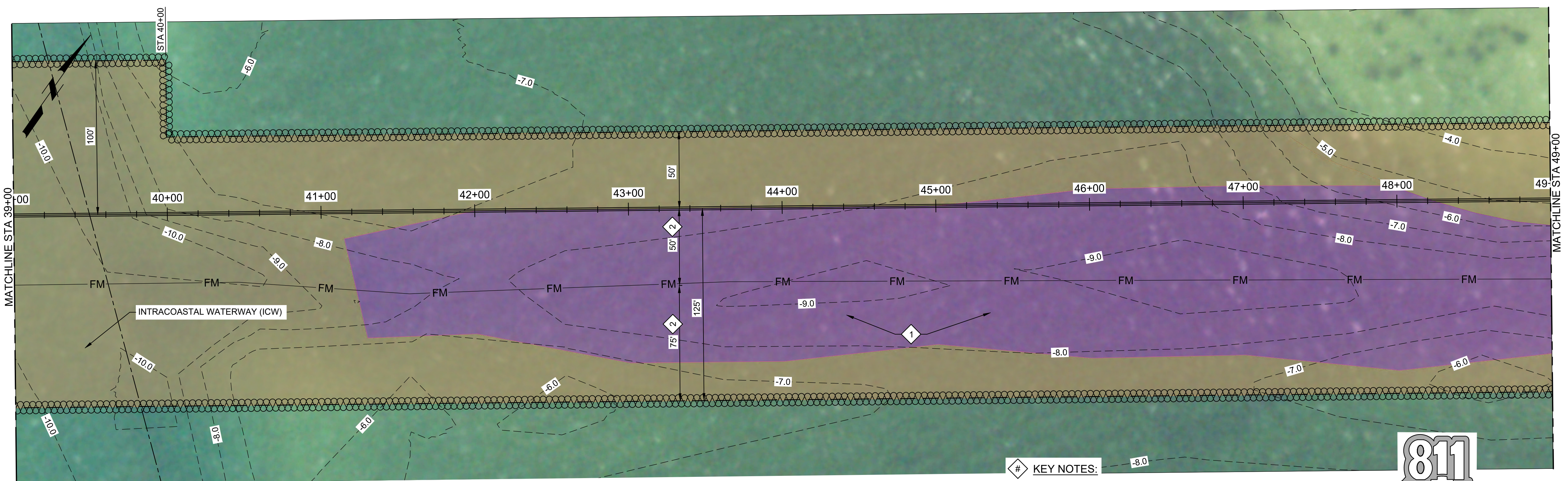
*Matthew Scott Richards*



TOWN OF LONGBOAT KEY  
ENVIRONMENTAL PERMITTING FOR  
SUBAQUEOUS FORCE MAIN  
CIVIL  
**PLAN AND PROFILE  
STA 29+00 TO 39+00**

VERIFY SCALES  
JOB NO. 11006H.10  
DRAWING NO. C02  
SHEET NO. 3 OF 15





**PLAN**  
FILE: 11006H1001C100

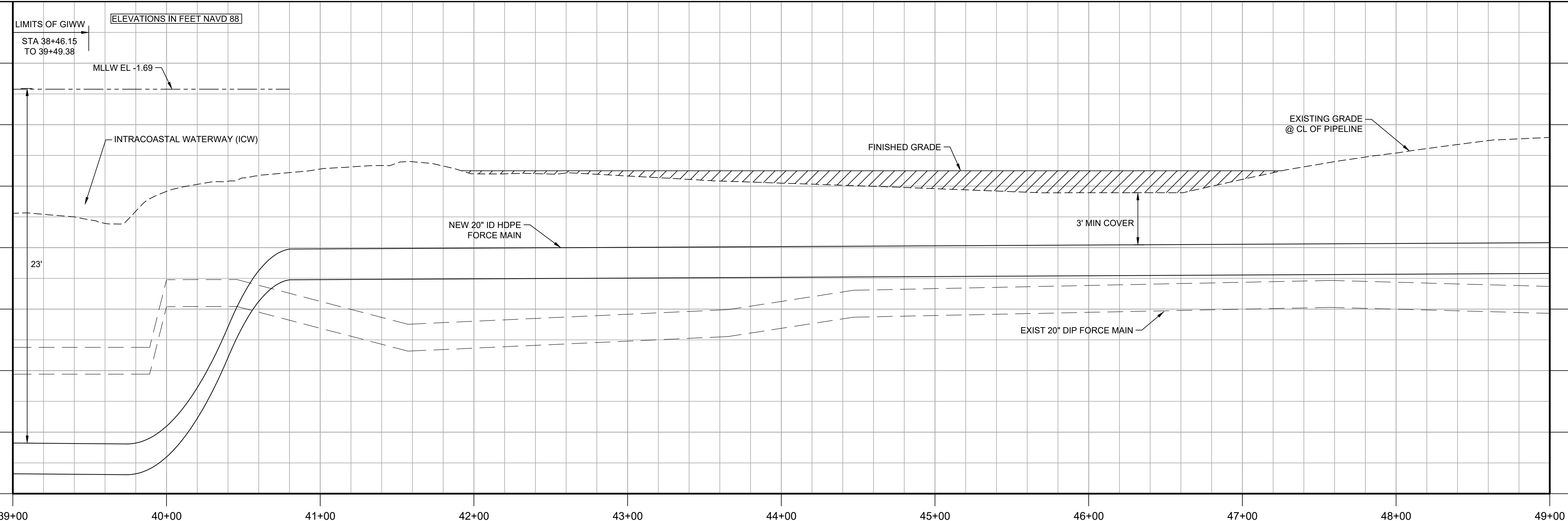
- KEY NOTES:**
1. AVERAGE FILL 1.5 FEET.
  2. THIS DIMENSION IS APPROXIMATE DUE TO THE VARIANCE OF THE EXISTING FORCE MAIN.



- GENERAL NOTES:**
1. 50' FROM CL OF NEW 20" ID HDPE FORCE MAIN (FM) PIPE TO EXISTING 20" DIP FORCE MAIN.
  2. EXISTING 20" DIP FM SHOWN IN PROFILE AS REFERENCE ONLY.
  3. THE EXISTING FORCE MAIN IS TO REMAIN IN PLACE FOR FUTURE CONDITION ASSESSMENT AND POTENTIAL REHABILITATION. AFTER REHABILITATION, EXISTING FORCE MAIN MAY BE USED AS A REDUNDANT FORCE MAIN OR FOR BRINGING RECLAIMED WATER TO THE TOWN.
  4. BACKFILLING SHOULD BE DONE CAREFULLY SO AS NOT TO CAUSE ANY SHOALING OF THE GULF INTERCOASTAL WATERWAY (GIWW) NAVIGATION CHANNEL.
  5. DEPTH OF PROPOSED FM SHALL BE AT -24 FOR THE FULL WIDTH OF THE GIWW PLUS 25 FEET ON EITHER SIDE, FOR A TOTAL OF 150 FEET.

**LEGEND**

- FM — EXISTING FORCE MAIN
- ===== PROPOSED FORCE MAIN
- - - - CONSTRUCTION LIMITS
- LIMITS OF JURISDICTIONAL WETLANDS
- ~ SHEET PILE
- ⊗ TURBIDITY CURTAIN
- NON-VEGETATED BAY BOTTOM
- PATCHY SEAGRASS
- CONTINUOUS SEAGRASS
- OYSTERS
- INTERTIDAL WETLAND (MANGROVES)
- FRESHWATER WETLAND
- UPLANDS
- SEAGRASS RESTORATION FILL AREAS
- RIPRAP



**PROFILE**  
FILE: 11006H1001C100

**KEY MAP**

**SCALE**

0 20' 40' 80'  
SCALE: 1" = 40' (HORIZ)

0 5' 10' 20'  
SCALE: 1" = 10' (VERT)

**KEY MAP NORTH**

**PERMIT PLANS NOT FOR CONSTRUCTION**

REV	DATE	BY	DESCRIPTION
1			
2			
3			

DESIGNED MAF  
DRAWN BWH  
CHECKED SR  
DATE DECEMBER 2021

**MATTHEW S. RICHARDS**  
No. 71505  
STATE OF FLORIDA  
PROFESSIONAL ENGINEER

Digitally signed by Matthew Scott Richards  
Contact Info: Carollo Engineers, Inc.  
Date: 2021.12.17 14:43:28-0500

*Matthew Scott Richards*



TOWN OF LONGBOAT KEY  
ENVIRONMENTAL PERMITTING FOR  
SUBAQUEOUS FORCE MAIN  
CIVIL  
**PLAN AND PROFILE**  
STA 39+00 TO 49+00

**VERIFY SCALES**

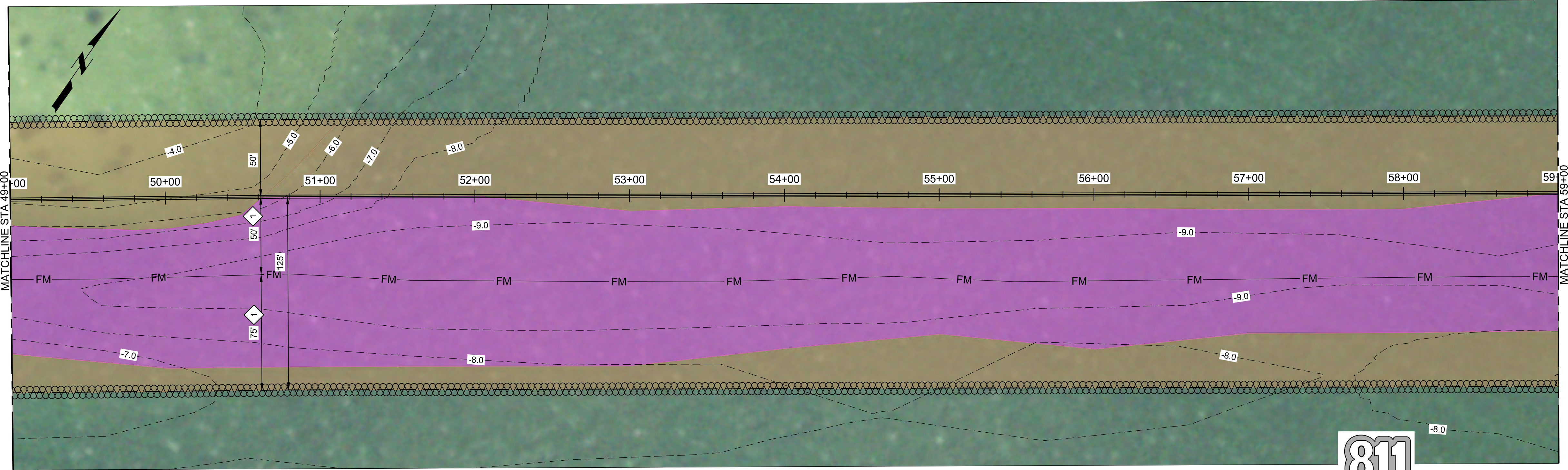
BAR IS ONE INCH ON ORIGINAL DRAWING

0 1"

IF NOT ONE INCH ON THIS SHEET, ADJUST SCALES ACCORDINGLY

JOB NO. 11006H.10
DRAWING NO. <b>C03</b>
SHEET NO. 4 OF 15





**PLAN**  
FILE: 11006H1001C100



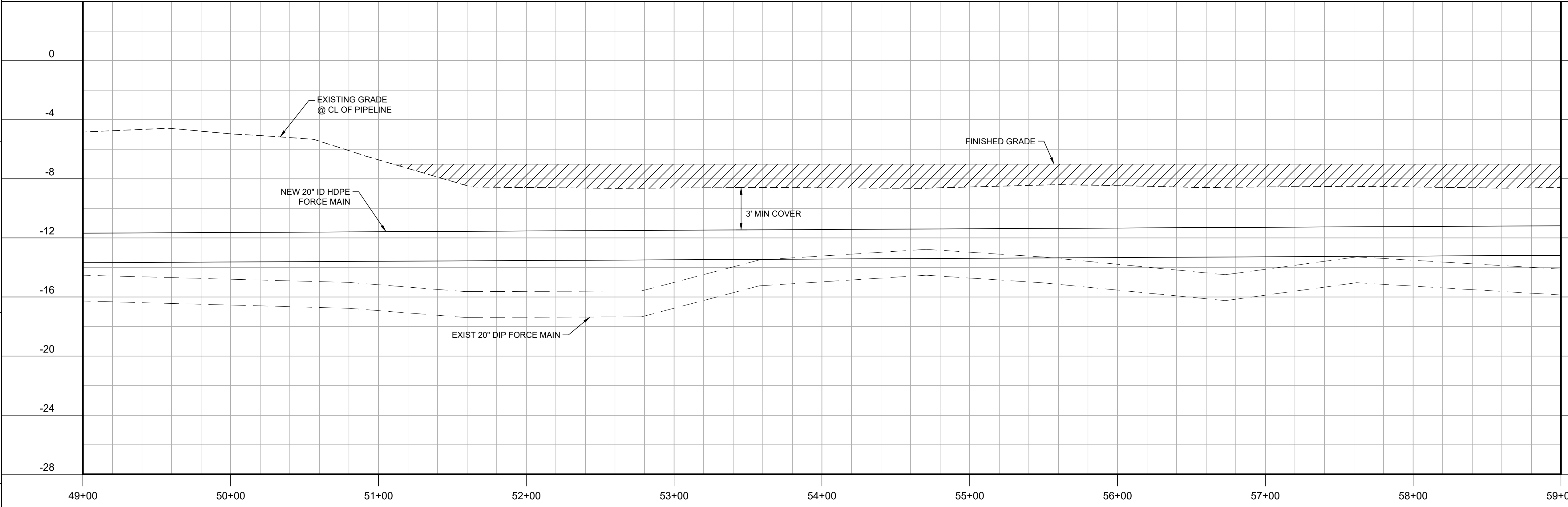
Know what's below.  
Call before you dig.

- GENERAL NOTES:**
- 50' FROM CL OF NEW 20" ID HDPE FORCE MAIN (FM) PIPE TO EXISTING 20" DIP FORCE MAIN.
  - EXISTING 20" DIP FM SHOWN IN PROFILE AS REFERENCE ONLY.
  - THE EXISTING FORCE MAIN IS TO REMAIN IN PLACE FOR FUTURE CONDITION ASSESSMENT AND POTENTIAL REHABILITATION. AFTER REHABILITATION, EXISTING FORCE MAIN MAY BE USED AS A REDUNDANT FORCE MAIN OR FOR BRINGING RECLAIMED WATER TO THE TOWN.

- KEY NOTES:**
- THIS DIMENSION IS APPROXIMATE DUE TO THE VARIANCE OF THE EXISTING FORCE MAIN.

**LEGEND**

- FM — EXISTING FORCE MAIN
- FM — PROPOSED FORCE MAIN
- - - CONSTRUCTION LIMITS
- LIMITS OF JURISDICTIONAL WETLANDS
- ~ SHEET PILE
- ⊗ TURBIDITY CURTAIN
- NON-VEGETATED BAY BOTTOM
- PATCHY SEAGRASS
- CONTINUOUS SEAGRASS
- OYSTERS
- INTERTIDAL WETLAND (MANGROVES)
- FRESHWATER WETLAND
- UPLANDS
- SEAGRASS RESTORATION FILL AREAS
- RIPRAP



**PROFILE**  
FILE: 11006H1001C100

**KEY MAP**

**SCALE**

0 20' 40' 80'  
SCALE: 1" = 40' (HORIZ)

0 5' 10' 20'  
SCALE: 1" = 10' (VERT)

**KEY MAP NORTH**

**PERMIT PLANS  
NOT FOR CONSTRUCTION**

REV	DATE	BY	DESCRIPTION
1			
2			

DESIGNED MAF	
DRAWN BWH	
CHECKED SR	
DATE DECEMBER 2021	

Digitally signed by Matthew Scott Richards  
Contact Info: Carollo Engineers, Inc.  
Date: 2021.12.17 14:30:44-0500



TOWN OF LONGBOAT KEY  
ENVIRONMENTAL PERMITTING FOR  
SUBAQUEOUS FORCE MAIN  
CIVIL  
**PLAN AND PROFILE  
STA 49+00 TO 59+00**

VERIFY SCALES	JOB NO. 11006H.10
BAR IS ONE INCH ON ORIGINAL DRAWING	DRAWING NO. <b>C04</b>
IF NOT ONE INCH ON THIS SHEET, ADJUST SCALES ACCORDINGLY	SHEET NO. 5 OF 15

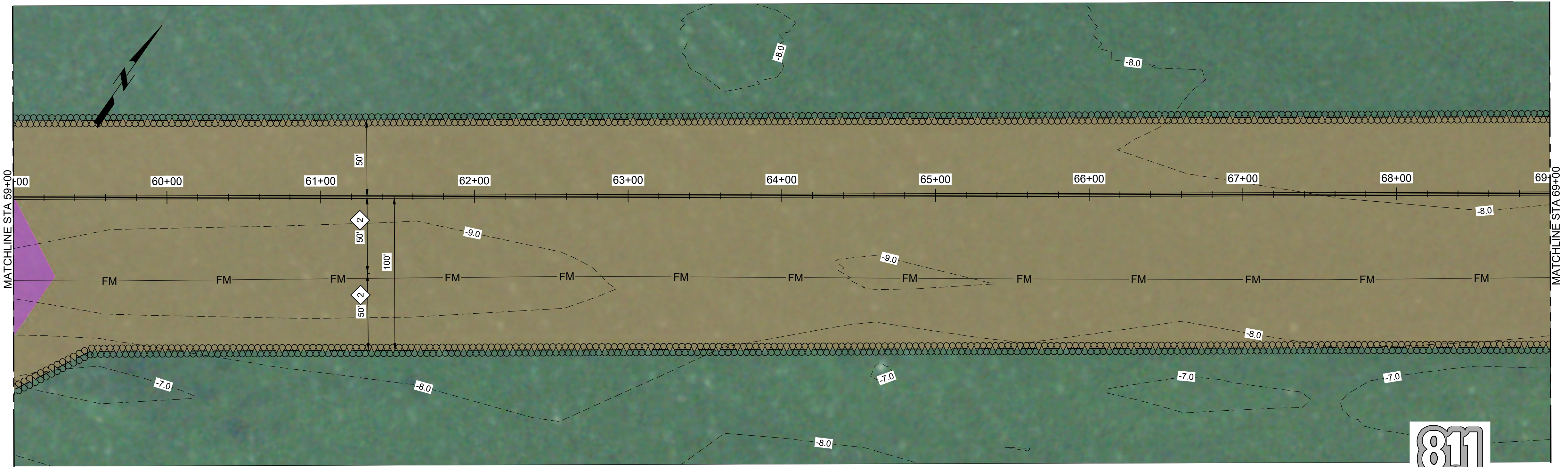


Plot Date: 12/16/2021 1:58:04 PM

FILE NAME: 11006H10C006.dwg

PROJECT NO.: 11006H10

LAST SAVED BY: bhwaves



**PLAN**  
FILE: 11006H1001C100

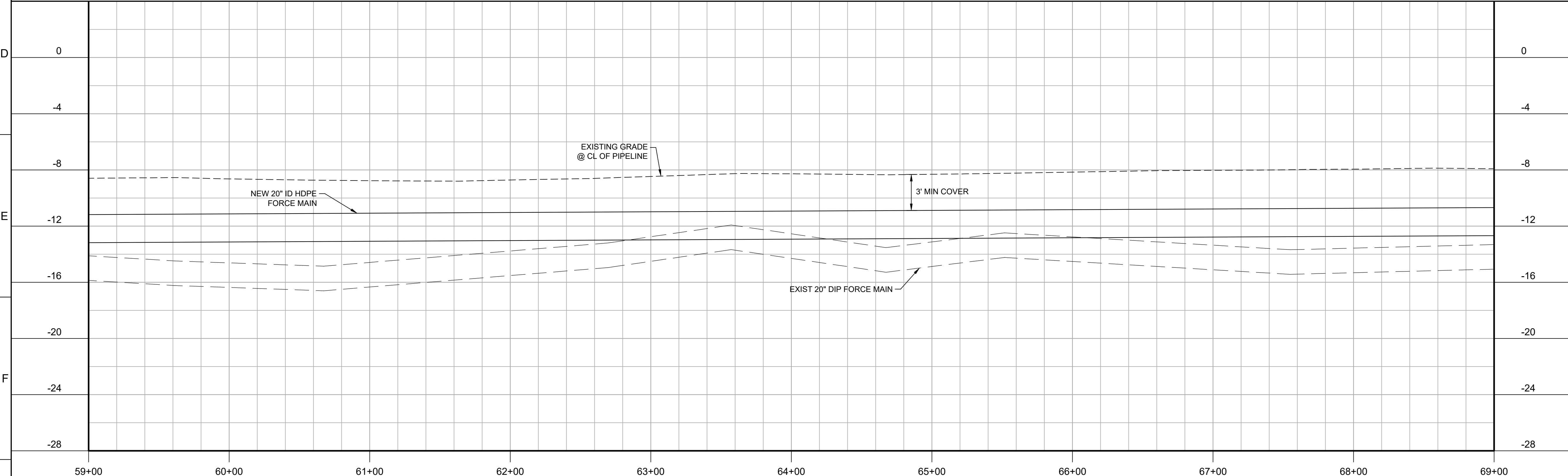


Know what's below.  
Call before you dig.

- GENERAL NOTES:**
- 50' FROM CL OF NEW 20" ID HDPE FORCE MAIN (FM) PIPE TO EXISTING 20" DIP FORCE MAIN.
  - EXISTING 20" DIP FM SHOWN IN PROFILE AS REFERENCE ONLY.
  - THE EXISTING FORCE MAIN IS TO REMAIN IN PLACE FOR FUTURE CONDITION ASSESSMENT AND POTENTIAL REHABILITATION. AFTER REHABILITATION, EXISTING FORCE MAIN MAY BE USED AS A REDUNDANT FORCE MAIN OR FOR BRINGING RECLAIMED WATER TO THE TOWN.

- KEY NOTES:**
- AVERAGE FILL 1.5 FEET.
  - THIS DIMENSION IS APPROXIMATE DUE TO THE VARIANCE OF THE EXISTING FORCE MAIN.

- LEGEND**
- FM — EXISTING FORCE MAIN
  - ===== PROPOSED FORCE MAIN
  - - - - CONSTRUCTION LIMITS
  - LIMITS OF JURISDICTIONAL WETLANDS
  - ~ ~ ~ ~ SHEET PILE
  - ⊗ ⊗ ⊗ ⊗ TURBIDITY CURTAIN
  - NON-VEGETATED BAY BOTTOM
  - PATCHY SEAGRASS
  - CONTINUOUS SEAGRASS
  - OYSTERS
  - INTERTIDAL WETLAND (MANGROVES)
  - FRESHWATER WETLAND
  - UPLANDS
  - SEAGRASS RESTORATION FILL AREAS
  - RIPRAP



**PROFILE**  
FILE: 11006H1001C100

**KEY MAP**

**SCALE**

0 20' 40' 80'  
SCALE: 1" = 40' (HORIZ)

0 5' 10' 20'  
SCALE: 1" = 10' (VERT)

**KEY MAP NORTH**

**PERMIT PLANS  
NOT FOR CONSTRUCTION**

REV	DATE	BY	DESCRIPTION
1			
2			

DESIGNED MAF  
DRAWN BWH  
CHECKED SR  
DATE DECEMBER 2021

**MATHEW S. RICHARDS**  
LICENSE No. 71505  
STATE OF FLORIDA  
PROFESSIONAL ENGINEER

Digitally signed by Matthew Scott Richards  
Contact Info: Carollo Engineers, Inc.  
Date: 2021.12.17 14:10:28-0500

*Matthew Scott Richards*



TOWN OF LONGBOAT KEY  
ENVIRONMENTAL PERMITTING FOR  
SUBAQUEOUS FORCE MAIN  
CIVIL  
**PLAN AND PROFILE  
STA 59+00 TO 69+00**

**VERIFY SCALES**

BAR IS ONE INCH ON ORIGINAL DRAWING

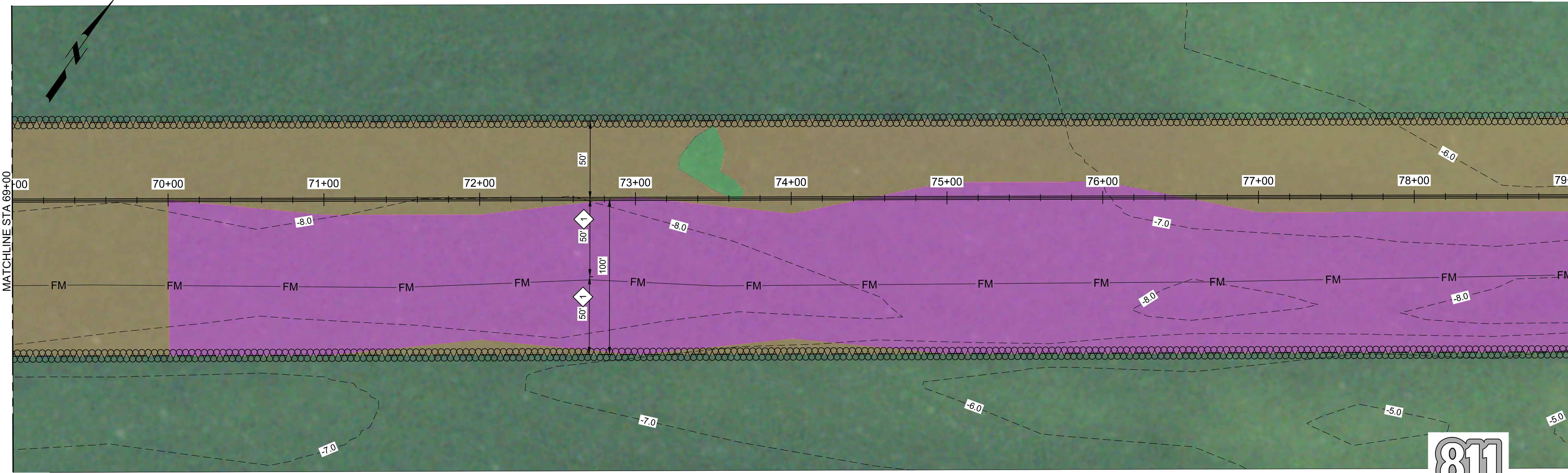
0 1" 1"

IF NOT ONE INCH ON THIS SHEET, ADJUST SCALES ACCORDINGLY

JOB NO. 11006H.10
DRAWING NO. <b>C05</b>
SHEET NO. 6 OF 15



12/16/2021 2:00:36 PM  
 FILE NAME: 11006H10C06.dwg  
 PROJECT NO. 11006H10  
 LAST SAVED BY: bhwaves



**PLAN**  
FILE: 11006H1001C100

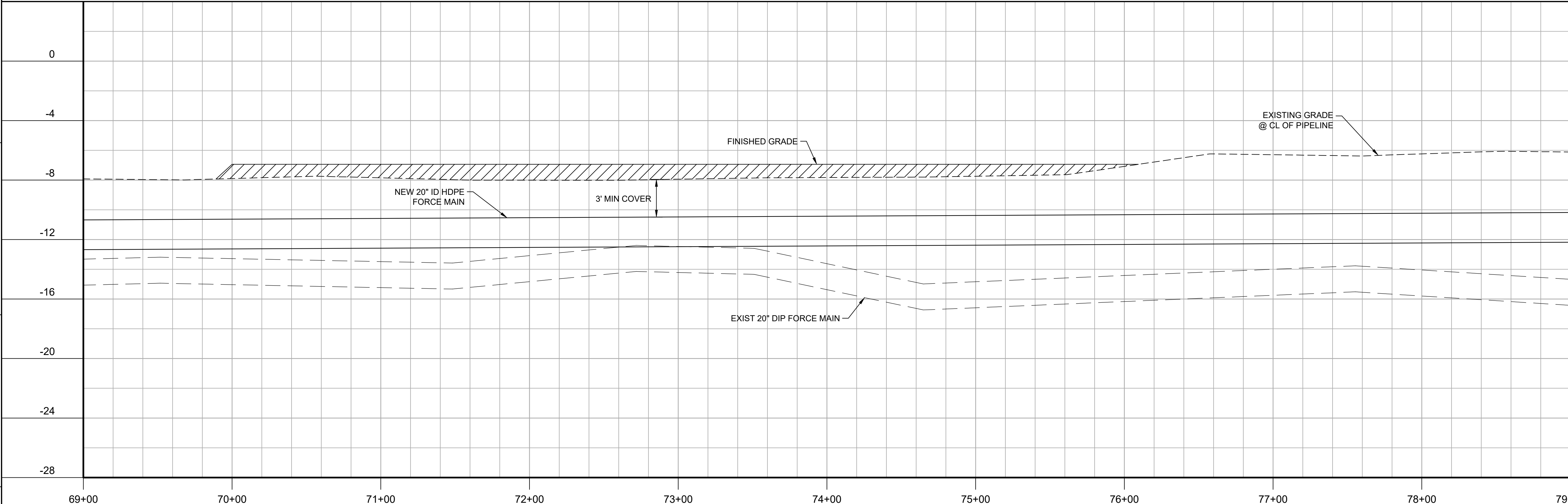


Know what's below.  
Call before you dig.

- GENERAL NOTES:**
- 50' FROM CL OF NEW 20" ID HDPE FORCE MAIN (FM) PIPE TO EXISTING 20" DIP FORCE MAIN.
  - EXISTING 20" DIP FM SHOWN IN PROFILE AS REFERENCE ONLY.
  - THE EXISTING FORCE MAIN IS TO REMAIN IN PLACE FOR FUTURE CONDITION ASSESSMENT AND POTENTIAL REHABILITATION. AFTER REHABILITATION, EXISTING FORCE MAIN MAY BE USED AS A REDUNDANT FORCE MAIN OR FOR BRINGING RECLAIMED WATER TO THE TOWN.

- KEY NOTES:**
- THIS DIMENSION IS APPROXIMATE DUE TO THE VARIANCE OF THE EXISTING FORCE MAIN.

- LEGEND**
- FM — EXISTING FORCE MAIN
  - ===== PROPOSED FORCE MAIN
  - - - - CONSTRUCTION LIMITS
  - LIMITS OF JURISDICTIONAL WETLANDS
  - ~ ~ ~ ~ SHEET PILE
  - ⊗ ⊗ ⊗ ⊗ TURBIDITY CURTAIN
  - NON-VEGETATED BAY BOTTOM
  - PATCHY SEAGRASS
  - CONTINUOUS SEAGRASS
  - OYSTERS
  - INTERTIDAL WETLAND (MANGROVES)
  - FRESHWATER WETLAND
  - UPLANDS
  - SEAGRASS RESTORATION FILL AREAS
  - RIPRAP



**PROFILE**  
FILE: 11006H1001C100

**KEY MAP**

**SCALE**

0 20' 40' 80'  
SCALE: 1" = 40' (HORIZ)

0 5' 10' 20'  
SCALE: 1" = 10' (VERT)

**KEY MAP NORTH**

**PERMIT PLANS  
NOT FOR CONSTRUCTION**

REV	DATE	BY	DESCRIPTION
1			
2			

DESIGNED MAF  
DRAWN BWH  
CHECKED SR  
DATE DECEMBER 2021

Digitally signed by Matthew Scott Richards  
Contact Info: Carollo Engineers, Inc.  
Date: 2021.12.17 14:30:04-0500



TOWN OF LONGBOAT KEY  
ENVIRONMENTAL PERMITTING FOR  
SUBAQUEOUS FORCE MAIN  
CIVIL  
**PLAN AND PROFILE  
STA 69+00 TO 79+00**

**VERIFY SCALES**

BAR IS ONE INCH ON ORIGINAL DRAWING

0 1" 1"

IF NOT ONE INCH ON THIS SHEET, ADJUST SCALES ACCORDINGLY

JOB NO. 11006H.10
DRAWING NO. <b>C06</b>
SHEET NO. 7 OF 15

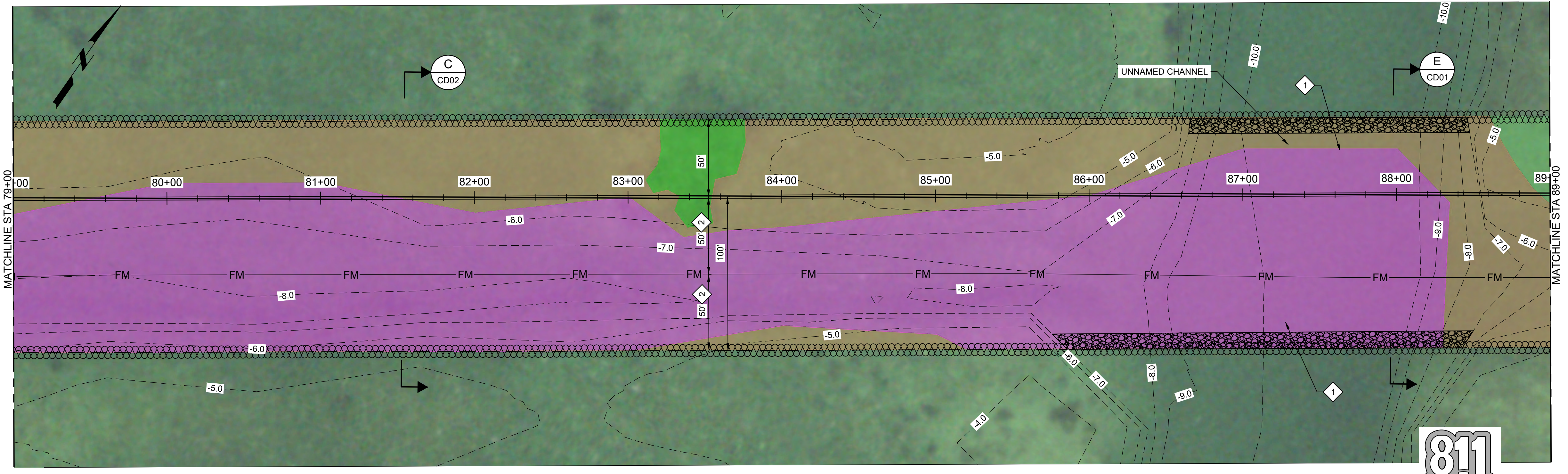


Plot Date: 12/16/2021 2:00:53 PM

FILE NAME: 11006H10C007.dwg

PROJECT NO.: 11006H10

LAST SAVED BY: bhwaves



**PLAN**  
FILE: 11006H1001C100

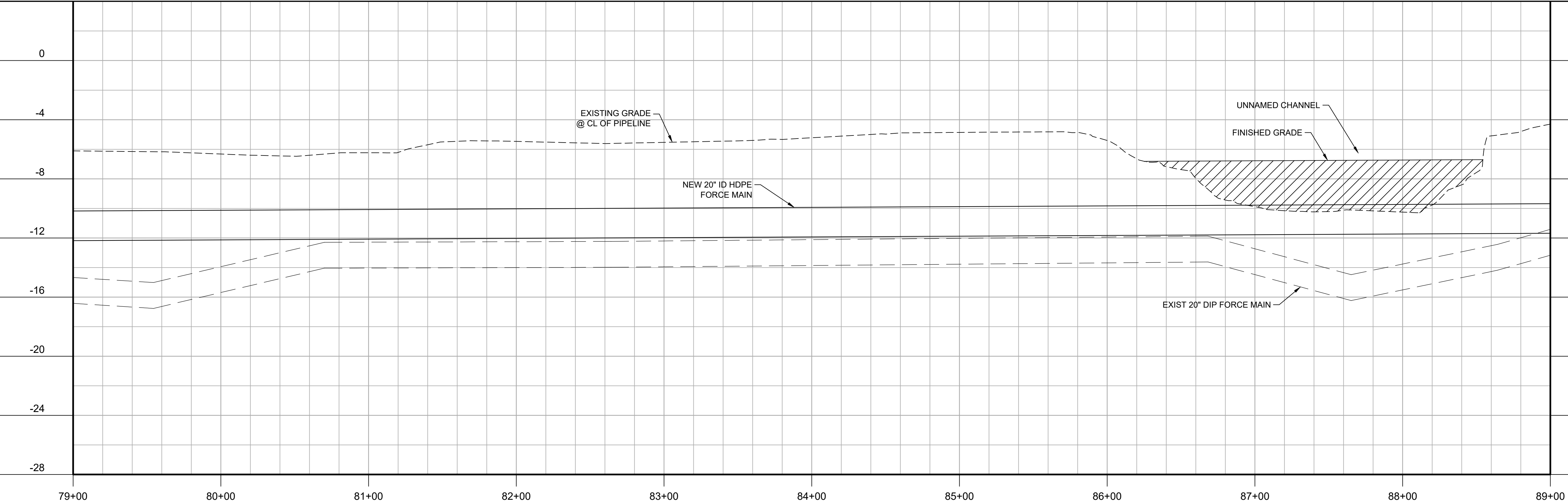


- GENERAL NOTES:**
- 50' FROM CL OF NEW 20" ID HDPE FORCE MAIN (FM) PIPE TO EXISTING 20" DIP FORCE MAIN.
  - EXISTING 20" DIP FM SHOWN IN PROFILE AS REFERENCE ONLY.
  - THE EXISTING FORCE MAIN IS TO REMAIN IN PLACE FOR FUTURE CONDITION ASSESSMENT AND POTENTIAL REHABILITATION. AFTER REHABILITATION, EXISTING FORCE MAIN MAY BE USED AS A REDUNDANT FORCE MAIN OR FOR BRINGING RECLAIMED WATER TO THE TOWN.

- KEY NOTES:**
- AVERAGE FILL 3.0 FEET.
  - THIS DIMENSION IS APPROXIMATE DUE TO THE VARIANCE OF THE EXISTING FORCE MAIN.

**LEGEND**

- FM — EXISTING FORCE MAIN
- ===== PROPOSED FORCE MAIN
- - - CONSTRUCTION LIMITS
- LIMITS OF JURISDICTIONAL WETLANDS
- ~ SHEET PILE
- ⊗ TURBIDITY CURTAIN
- NON-VEGETATED BAY BOTTOM
- PATCHY SEAGRASS
- CONTINUOUS SEAGRASS
- OYSTERS
- INTERTIDAL WETLAND (MANGROVES)
- FRESHWATER WETLAND
- UPLANDS
- SEAGRASS RESTORATION FILL AREAS
- RIPRAP



**PROFILE**  
FILE: 11006H1001C100

**KEY MAP**

**SCALE**

0 20' 40' 80'  
SCALE: 1" = 40' (HORIZ)

0 5' 10' 20'  
SCALE: 1" = 10' (VERT)

**KEY MAP NORTH**

**PERMIT PLANS NOT FOR CONSTRUCTION**

REV	DATE	BY	DESCRIPTION
1			
2			

DESIGNED MAF  
DRAWN BWH  
CHECKED SR  
DATE DECEMBER 2021

**MATTHEW S. RICHARDS**  
No. 71505  
STATE OF FLORIDA  
PROFESSIONAL ENGINEER

Digitally signed by Matthew Scott Richards  
Contact Info: Carollo Engineers, Inc.  
Date: 2021.12.17 14:50:36-0500

*Matthew Scott Richards*



TOWN OF LONGBOAT KEY  
ENVIRONMENTAL PERMITTING FOR  
SUBAQUEOUS FORCE MAIN  
CIVIL  
**PLAN AND PROFILE**  
STA 79+00 TO 89+00

**VERIFY SCALES**

BAR IS ONE INCH ON ORIGINAL DRAWING

0 1" 1"

IF NOT ONE INCH ON THIS SHEET, ADJUST SCALES ACCORDINGLY

JOB NO. 11006H.10
DRAWING NO. <b>C07</b>
SHEET NO. 8 OF 15

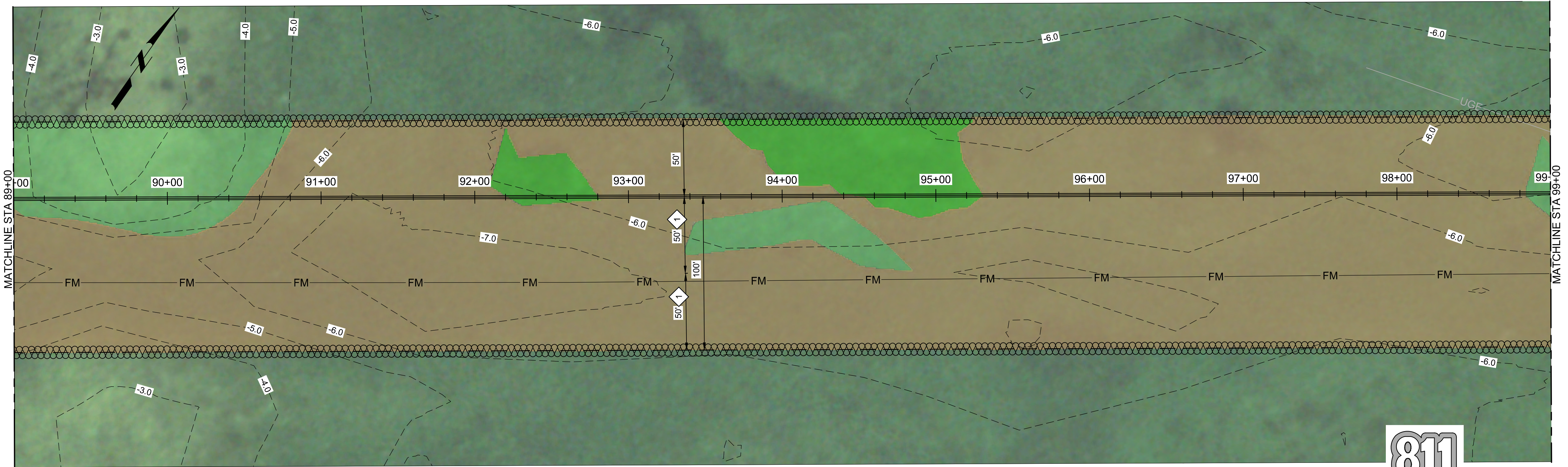


Plot Date: 12/16/2021 2:02:41 PM

FILE NAME: 11006H10C008.dwg

PROJECT NO.: 11006H10

LAST SAVED BY: bhawes



**PLAN**  
FILE: 11006H1001C100



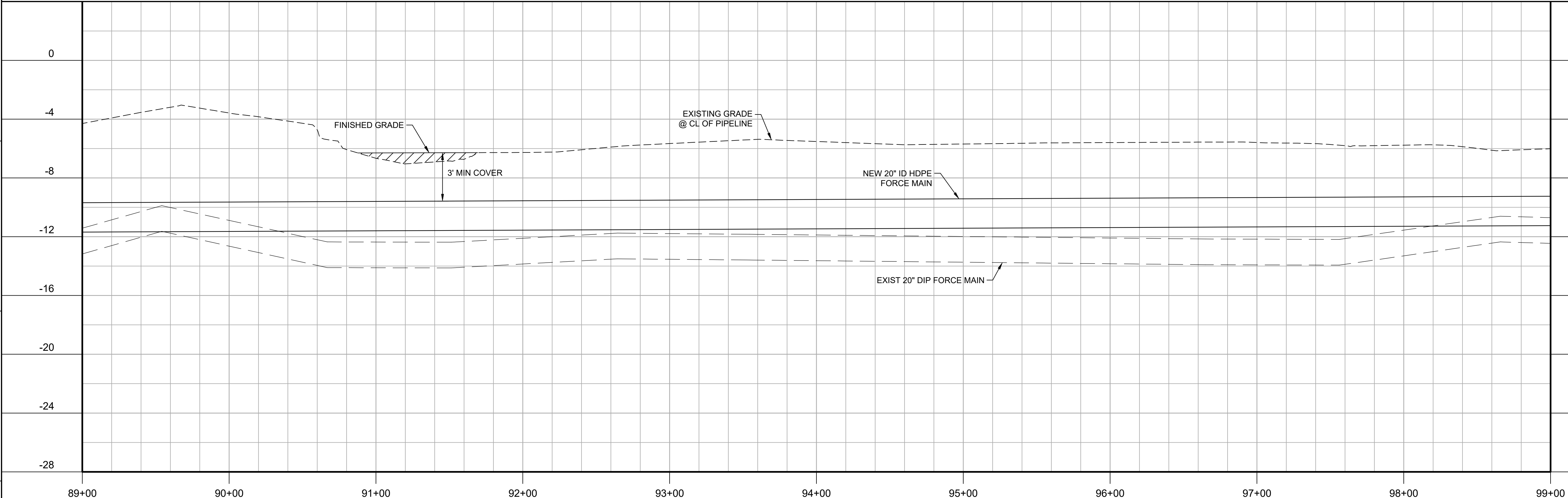
Know what's below.  
Call before you dig.

- GENERAL NOTES:**
- 50' FROM CL OF NEW 20" ID HDPE FORCE MAIN (FM) PIPE TO EXISTING 20" DIP FORCE MAIN.
  - EXISTING 20" DIP FM SHOWN IN PROFILE AS REFERENCE ONLY.
  - THE EXISTING FORCE MAIN IS TO REMAIN IN PLACE FOR FUTURE CONDITION ASSESSMENT AND POTENTIAL REHABILITATION. AFTER REHABILITATION, EXISTING FORCE MAIN MAY BE USED AS A REDUNDANT FORCE MAIN OR FOR BRINGING RECLAIMED WATER TO THE TOWN.

- KEY NOTES:**
- THIS DIMENSION IS APPROXIMATE DUE TO THE VARIANCE OF THE EXISTING FORCE MAIN.

**LEGEND**

- FM — EXISTING FORCE MAIN
- ===== PROPOSED FORCE MAIN
- - - - CONSTRUCTION LIMITS
- LIMITS OF JURISDICTIONAL WETLANDS
- ~ ~ ~ SHEET PILE
- ⊗ TURBIDITY CURTAIN
- NON-VEGETATED BAY BOTTOM
- PATCHY SEAGRASS
- CONTINUOUS SEAGRASS
- OYSTERS
- INTERTIDAL WETLAND (MANGROVES)
- FRESHWATER WETLAND
- UPLANDS
- SEAGRASS RESTORATION FILL AREAS
- RIPRAP



**PROFILE**  
FILE: 11006H1001C100

**KEY MAP**

**SCALE**

0 20' 40' 80'  
SCALE: 1" = 40' (HORIZ)

0 5' 10' 20'  
SCALE: 1" = 10' (VERT)

**KEY MAP NORTH**

**PERMIT PLANS NOT FOR CONSTRUCTION**

REV	DATE	BY	DESCRIPTION
1			
2			
3			

DESIGNED MAF  
DRAWN BWH  
CHECKED SR  
DATE DECEMBER 2021

**MATHEW S. RICHARDS**  
FLORIDA PROFESSIONAL ENGINEER  
No. 71505

Digitally signed by Matthew Scott Richards  
Contact Info: Carollo Engineers, Inc.  
Date: 2021.12.17 14:42:29-0500

*Matthew Scott Richards*



TOWN OF LONGBOAT KEY  
ENVIRONMENTAL PERMITTING FOR  
SUBAQUEOUS FORCE MAIN  
CIVIL  
**PLAN AND PROFILE**  
STA 89+00 TO 99+00

**VERIFY SCALES**

BAR IS ONE INCH ON ORIGINAL DRAWING

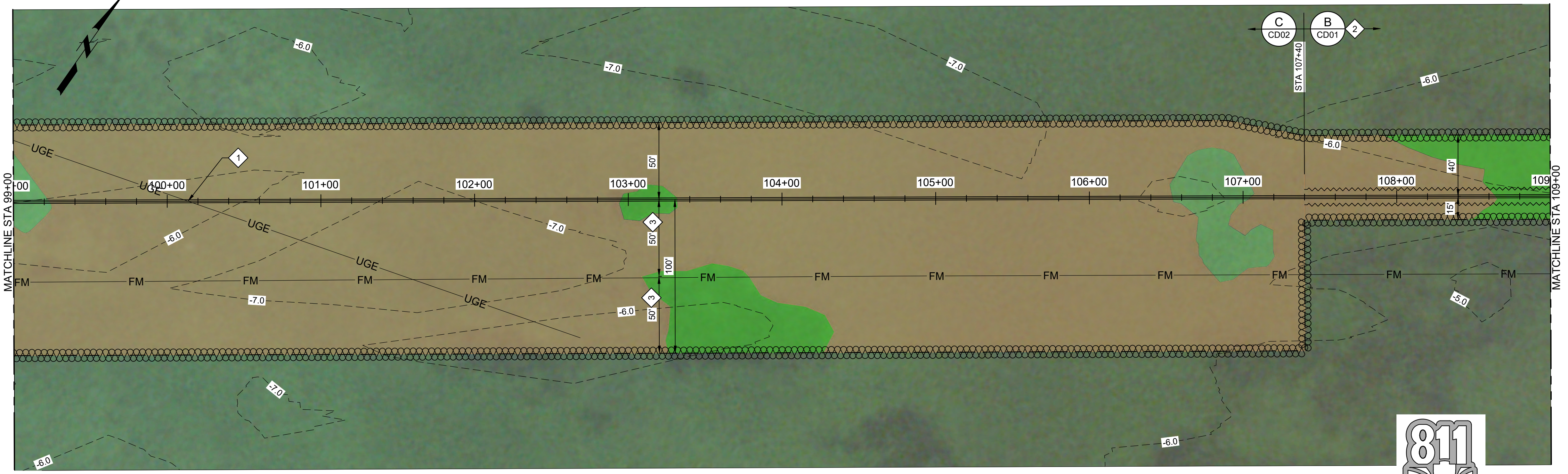
0 1" 1"

IF NOT ONE INCH ON THIS SHEET, ADJUST SCALES ACCORDINGLY

JOB NO. 11006H.10
DRAWING NO. <b>C08</b>
SHEET NO. 9 OF 15



12/17/2021  
 Plot Date: 12/16/2021 2:03:08 PM  
 FILE NAME: 11006H10C009.dwg  
 PROJECT NO.: 11006H10  
 LAST SAVED BY: bhwaves



**PLAN**  
FILE: 11006H1001C100

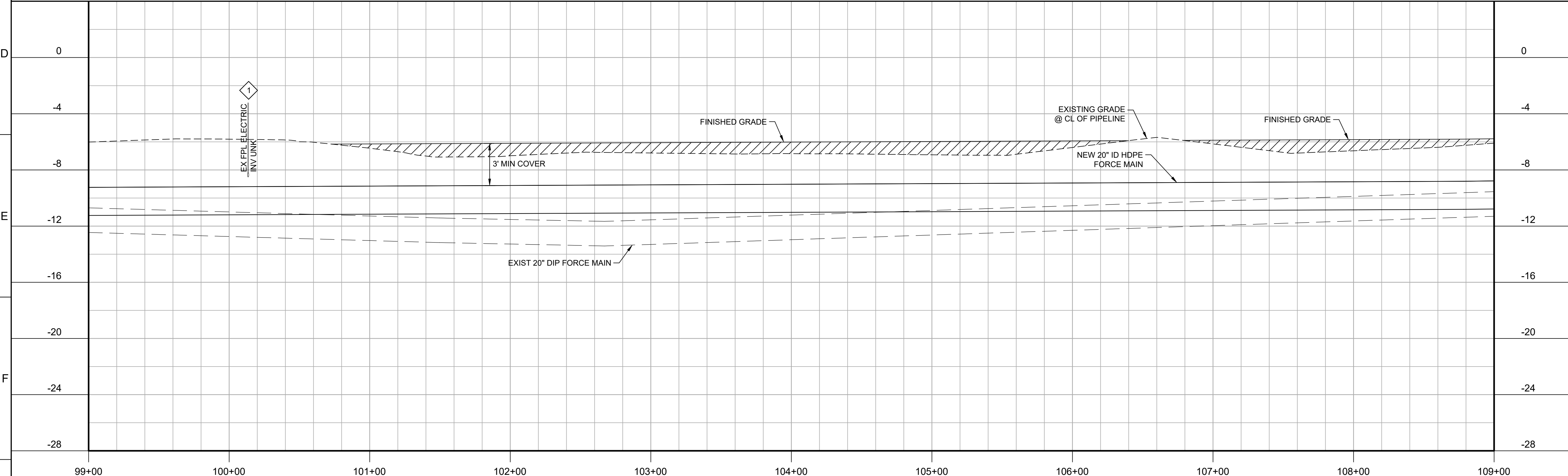
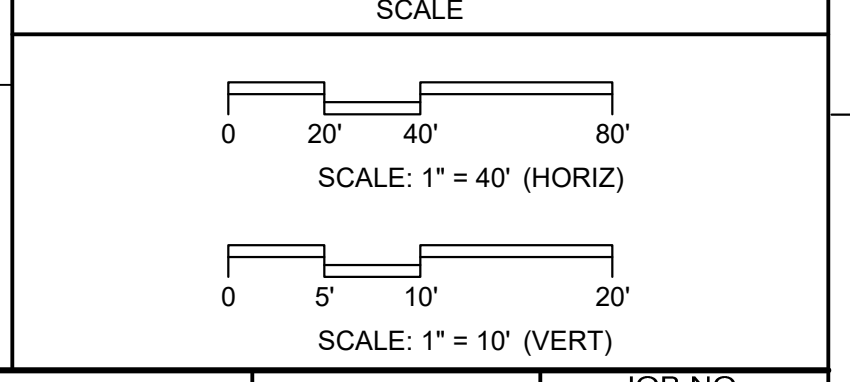
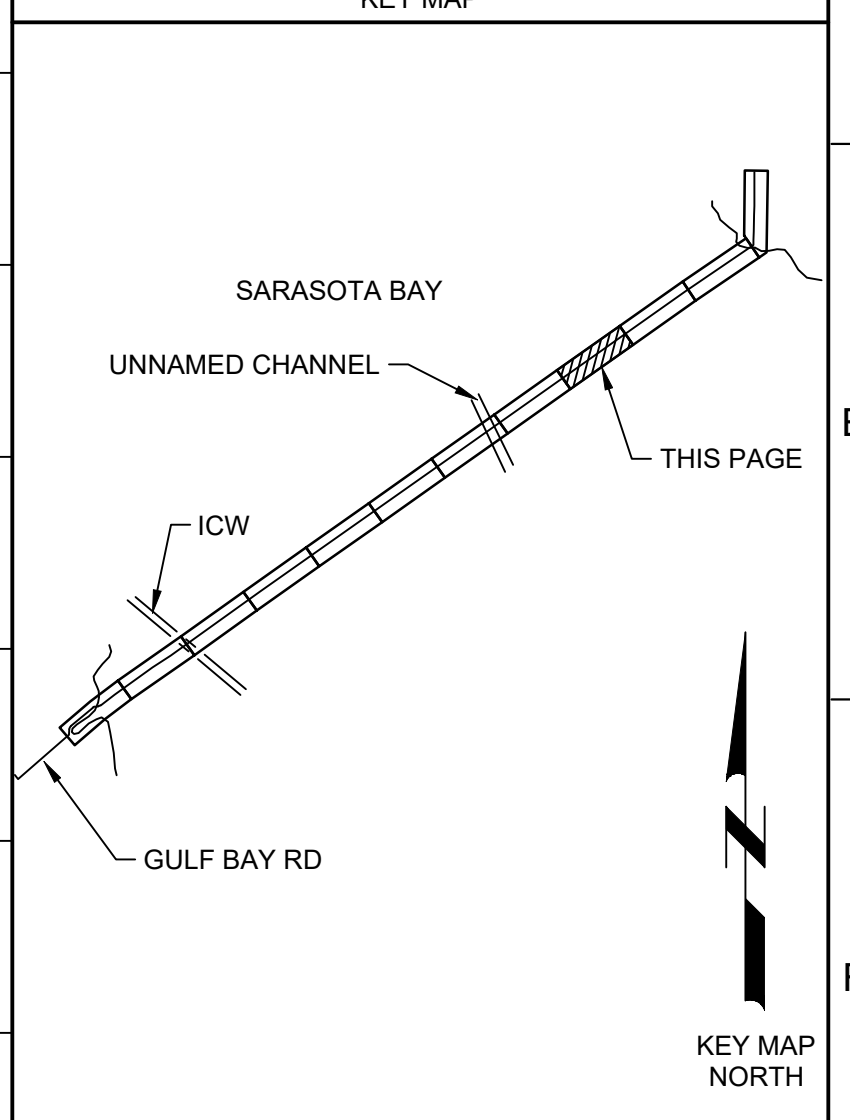
**Know what's below.  
Call before you dig.**

- GENERAL NOTES:**
- 50' FROM CL OF NEW 20" ID HDPE FORCE MAIN (FM) PIPE TO EXISTING 20" DIP FORCE MAIN.
  - EXISTING 20" DIP FM SHOWN IN PROFILE AS REFERENCE ONLY.
  - THE EXISTING FORCE MAIN IS TO REMAIN IN PLACE FOR FUTURE CONDITION ASSESSMENT AND POTENTIAL REHABILITATION. AFTER REHABILITATION, EXISTING FORCE MAIN MAY BE USED AS A REDUNDANT FORCE MAIN OR FOR BRINGING RECLAIMED WATER TO THE TOWN.

- KEY NOTES:**
- PROTECT IN PLACE.
  - BARGE LIMIT FLOATING.
  - THIS DIMENSION IS APPROXIMATE DUE TO THE VARIANCE OF THE EXISTING FORCE MAIN.

**LEGEND**

- FM EXISTING FORCE MAIN
- FM PROPOSED FORCE MAIN
- CONSTRUCTION LIMITS
- LIMITS OF JURISDICTIONAL WETLANDS
- SHEET PILE
- TURBIDITY CURTAIN
- NON-VEGETATED BAY BOTTOM
- PATCHY SEAGRASS
- CONTINUOUS SEAGRASS
- OYSTERS
- INTERTIDAL WETLAND (MANGROVES)
- FRESHWATER WETLAND
- UPLANDS
- SEAGRASS RESTORATION FILL AREAS
- RIPRAP



**PROFILE**  
FILE: 11006H1001C100

**PERMIT PLANS  
NOT FOR CONSTRUCTION**

REV	DATE	BY	DESCRIPTION
1			
2			

DESIGNED MAF  
DRAWN BWH  
CHECKED SR  
DATE DECEMBER 2021

**MATHEW S. RICHARDS**  
No. 71505  
STATE OF FLORIDA  
PROFESSIONAL ENGINEER

*Matthew S. Richards*

Digitally signed by Matthew Scott Richards  
Contact Info: Carollo Engineers, Inc.  
Date: 2021.12.17 14:47:28-0500



**TOWN OF LONGBOAT KEY**  
ENVIRONMENTAL PERMITTING FOR  
SUBAQUEOUS FORCE MAIN  
CIVIL  
**PLAN AND PROFILE**  
STA 99+00 TO 109+00

**VERIFY SCALES**

BAR IS ONE INCH ON ORIGINAL DRAWING

0 1" 1"

IF NOT ONE INCH ON THIS SHEET, ADJUST SCALES ACCORDINGLY

JOB NO. 11006H.10
DRAWING NO. <b>C09</b>
SHEET NO. 10 OF 15

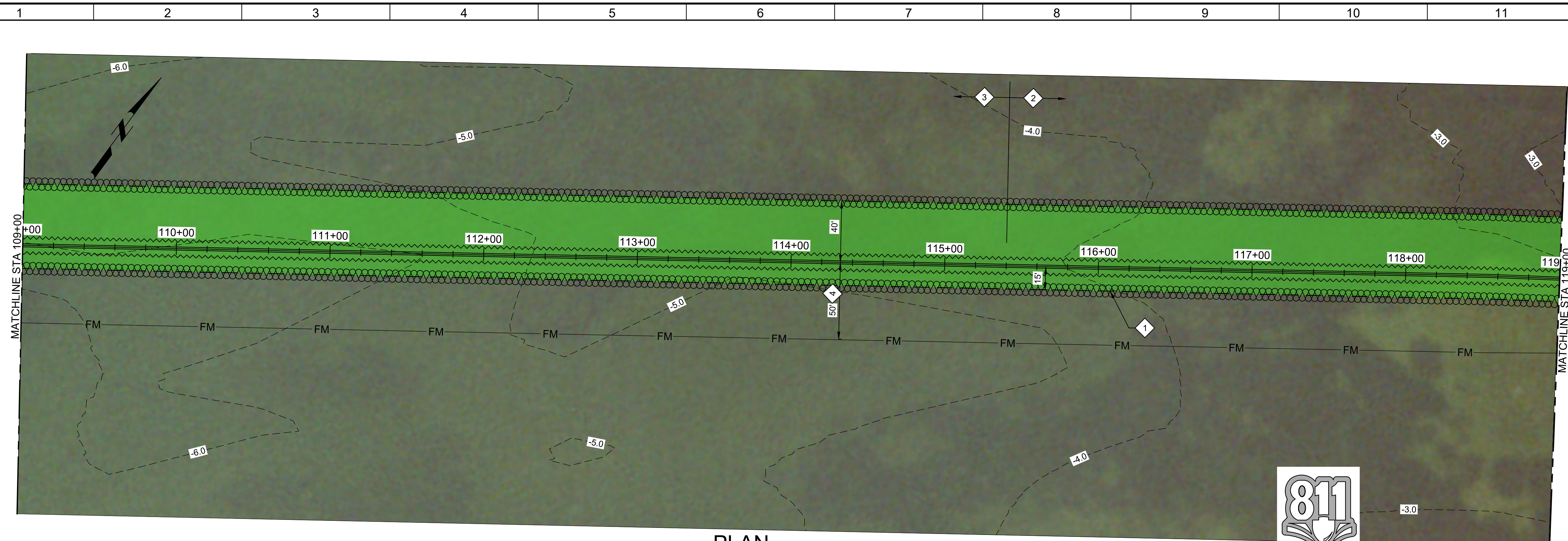


Plot Date: 12/16/2021 2:05:03 PM

FILE NAME: 11006H10C10.dwg

PROJECT NO. 11006H10

LAST SAVED BY: bhawes



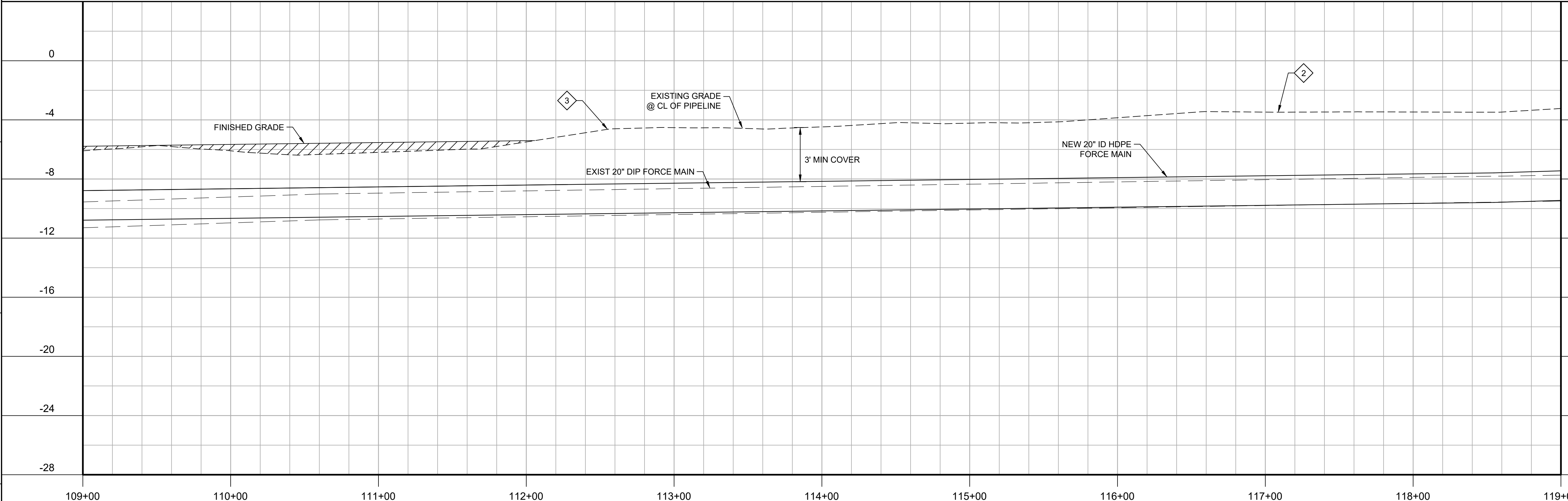
**PLAN**  
FILE: 11006H1001C100

Know what's below.  
Call before you dig.

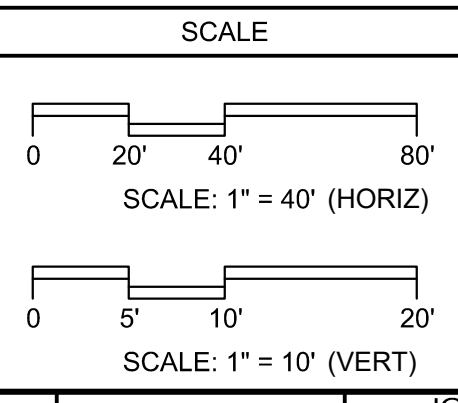
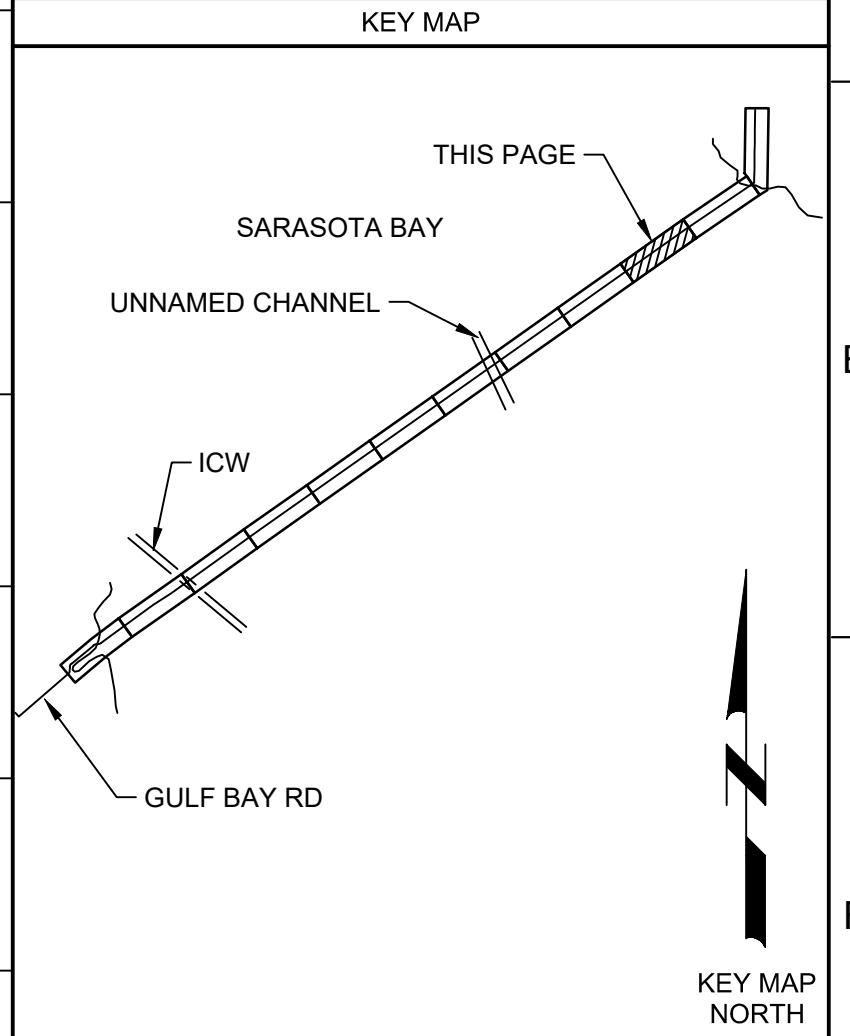
- GENERAL NOTES:**
- 50' FROM CL OF NEW 20" ID HDPE FORCE MAIN (FM) PIPE TO EXISTING 20" DIP FORCE MAIN.
  - EXISTING 20" DIP FM SHOWN IN PROFILE AS REFERENCE ONLY.
  - THE EXISTING FORCE MAIN IS TO REMAIN IN PLACE FOR FUTURE CONDITION ASSESSMENT AND POTENTIAL REHABILITATION. AFTER REHABILITATION, EXISTING FORCE MAIN MAY BE USED AS A REDUNDANT FORCE MAIN OR FOR BRINGING RECLAIMED WATER TO THE TOWN.

- KEY NOTES:**
- SOUTH CONSTRUCTION LIMIT.
  - BARGE LIMIT SITTING ON EXISTING GRADE TO SHORE.
  - BARGE LIMIT FLOATING.
  - THIS DIMENSION IS APPROXIMATE DUE TO THE VARIANCE OF THE EXISTING FORCE MAIN.

- LEGEND**
- FM — EXISTING FORCE MAIN
  - ===== PROPOSED FORCE MAIN
  - - - - CONSTRUCTION LIMITS
  - LIMITS OF JURISDICTIONAL WETLANDS
  - ~~~~~ SHEET PILE
  - ⊗ TURBIDITY CURTAIN
  - NON-VEGETATED BAY BOTTOM
  - PATCHY SEAGRASS
  - CONTINUOUS SEAGRASS
  - OYSTERS
  - INTERTIDAL WETLAND (MANGROVES)
  - FRESHWATER WETLAND
  - UPLANDS
  - SEAGRASS RESTORATION FILL AREAS
  - RIPRAP



**PROFILE**  
FILE: 11006H1001C100



**PERMIT PLANS NOT FOR CONSTRUCTION**

REV	DATE	BY	DESCRIPTION
1			
2			

DESIGNED MAF	
DRAWN BWH	
CHECKED SR	
DATE DECEMBER 2021	

Digitally signed by Matthew Scott Richards  
Contact Info: Carollo Engineers, Inc.  
Date: 2021.12.17 14:40:26-0500  
*Matthew Scott Richards*



TOWN OF LONGBOAT KEY  
ENVIRONMENTAL PERMITTING FOR  
SUBAQUEOUS FORCE MAIN  
CIVIL  
**PLAN AND PROFILE**  
STA 109+00 TO 119+00

VERIFY SCALES BAR IS ONE INCH ON ORIGINAL DRAWING 0 1" IF NOT ONE INCH ON THIS SHEET, ADJUST SCALES ACCORDINGLY	JOB NO. 11006H.10 DRAWING NO. <b>C10</b> SHEET NO. 11 OF 15
--	--

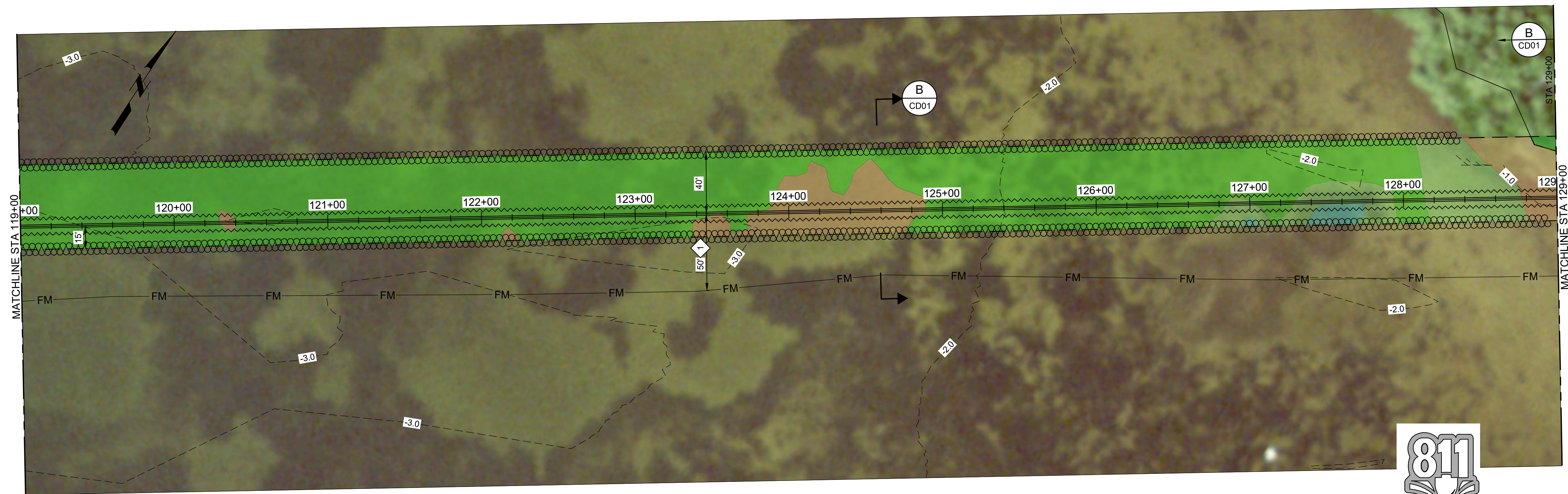


Plot Date: 12/16/2021 2:04:48 PM

FILE NAME: 11006H10C011.dwg

PROJECT NO.: 11006H10

LAST SAVED BY: bhwaves



**PLAN**  
FILE: 11006H1001C100

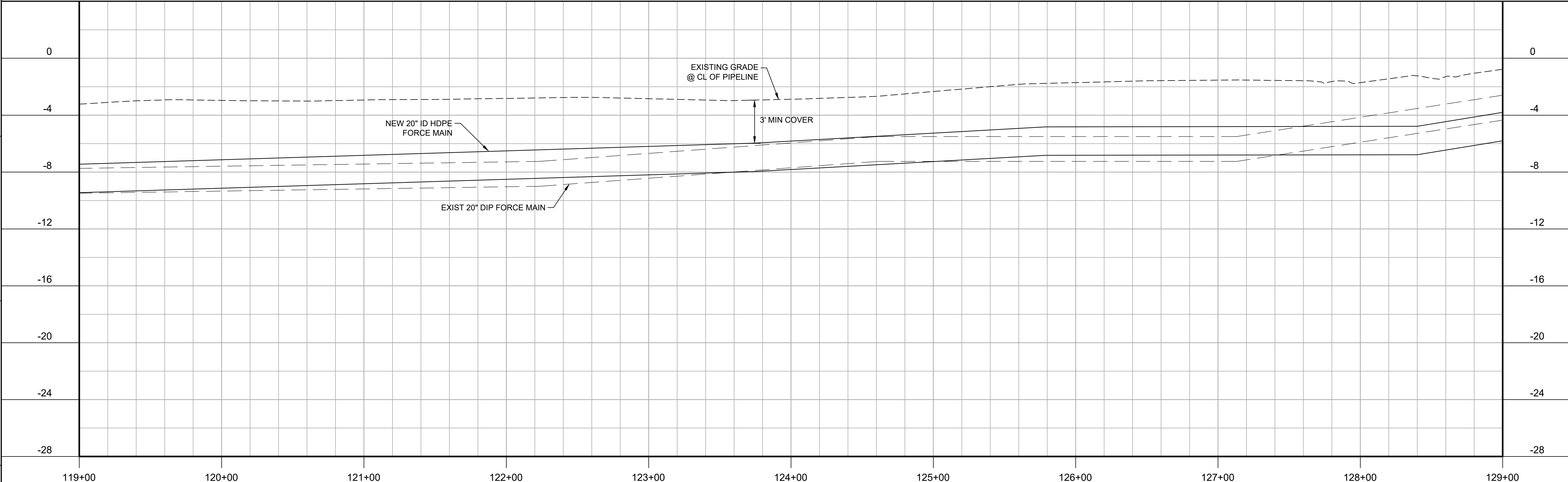
**811**  
Know what's below.  
Call before you dig.

- GENERAL NOTES:**
- 50' FROM CL OF NEW 20" ID HDPE FORCE MAIN (FM) PIPE TO EXISTING 20" DIP FORCE MAIN.
  - EXISTING 20" DIP FM SHOWN IN PROFILE AS REFERENCE ONLY.
  - THE EXISTING FORCE MAIN IS TO REMAIN IN PLACE FOR FUTURE CONDITION ASSESSMENT AND POTENTIAL REHABILITATION. AFTER REHABILITATION, EXISTING FORCE MAIN MAY BE USED AS A REDUNDANT FORCE MAIN OR FOR BRINGING RECLAIMED WATER TO THE TOWN.

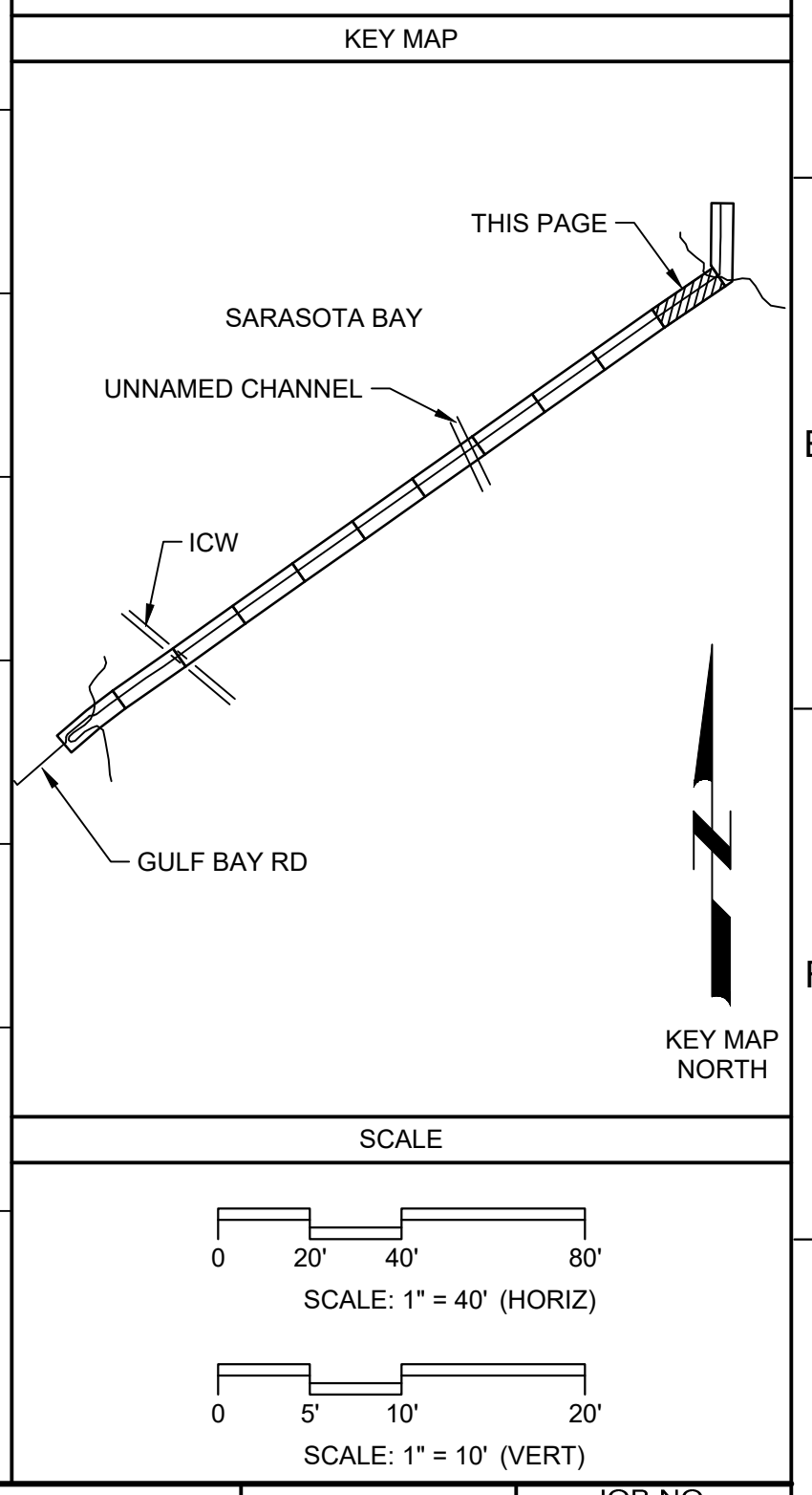
- KEY NOTES:**
- THIS DIMENSION IS APPROXIMATE DUE TO THE VARIANCE OF THE EXISTING FORCE MAIN.

**LEGEND**

	EXISTING FORCE MAIN
	PROPOSED FORCE MAIN
	CONSTRUCTION LIMITS
	LIMITS OF JURISDICTIONAL WETLANDS
	SHEET PILE
	TURBIDITY CURTAIN
	NON-VEGETATED BAY BOTTOM
	PATCHY SEAGRASS
	CONTINUOUS SEAGRASS
	OYSTERS
	INTERTIDAL WETLAND (MANGROVES)
	FRESHWATER WETLAND
	UPLANDS
	SEAGRASS RESTORATION FILL AREAS
	RIPRAP



**PROFILE**  
FILE: 11006H1001C100



**PERMIT PLANS NOT FOR CONSTRUCTION**

REV	DATE	BY	DESCRIPTION
1			
2			

DESIGNED MAF	
DRAWN BWH	
CHECKED SR	
DATE DECEMBER 2021	

Digitally signed by Matthew Scott Richards  
Contact Info: Carollo Engineers, Inc.  
Date: 2021.12.17 14:40:29-0500



TOWN OF LONGBOAT KEY  
ENVIRONMENTAL PERMITTING FOR  
SUBAQUEOUS FORCE MAIN  
CIVIL  
**PLAN AND PROFILE**  
STA 119+00 TO 129+00

VERIFY SCALES BAR IS ONE INCH ON ORIGINAL DRAWING 0 1" 1"	JOB NO. 11006H.10
IF NOT ONE INCH ON THIS SHEET, ADJUST SCALES ACCORDINGLY	DRAWING NO. <b>C11</b>
	SHEET NO. 12 OF 15

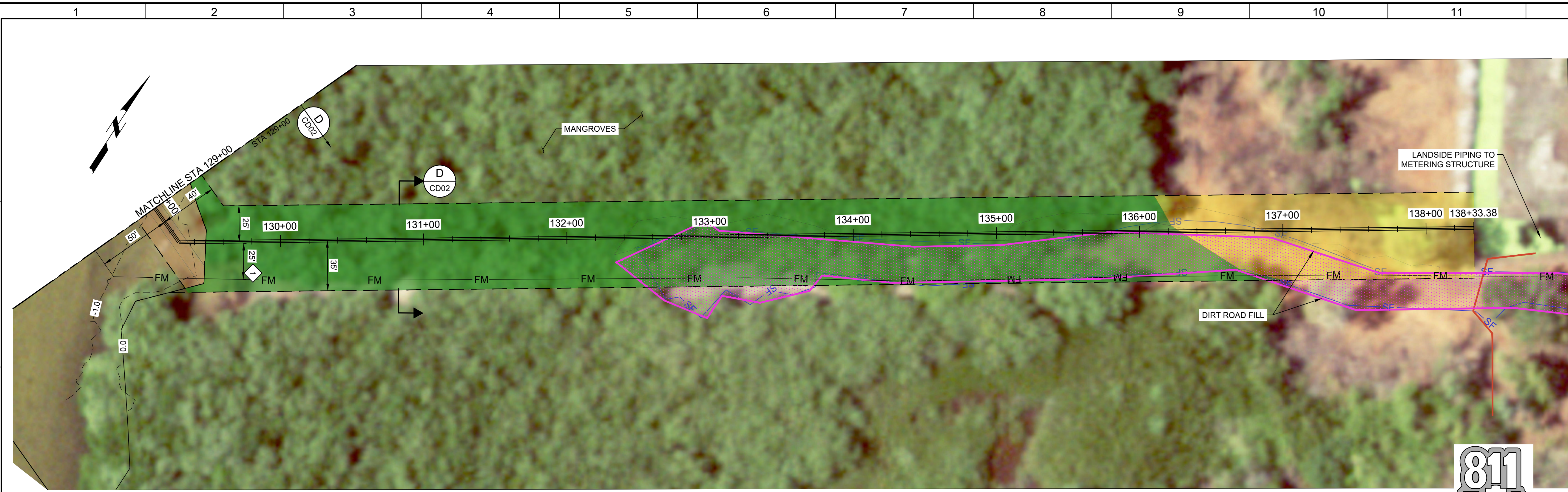


Plot Date: 12/16/2021 2:06:25 PM

FILE NAME: 11006H10012.dwg

PROJECT NO.: 11006H10

LAST SAVED BY: bhwaves



**PLAN**  
FILE: 11006H1001C100



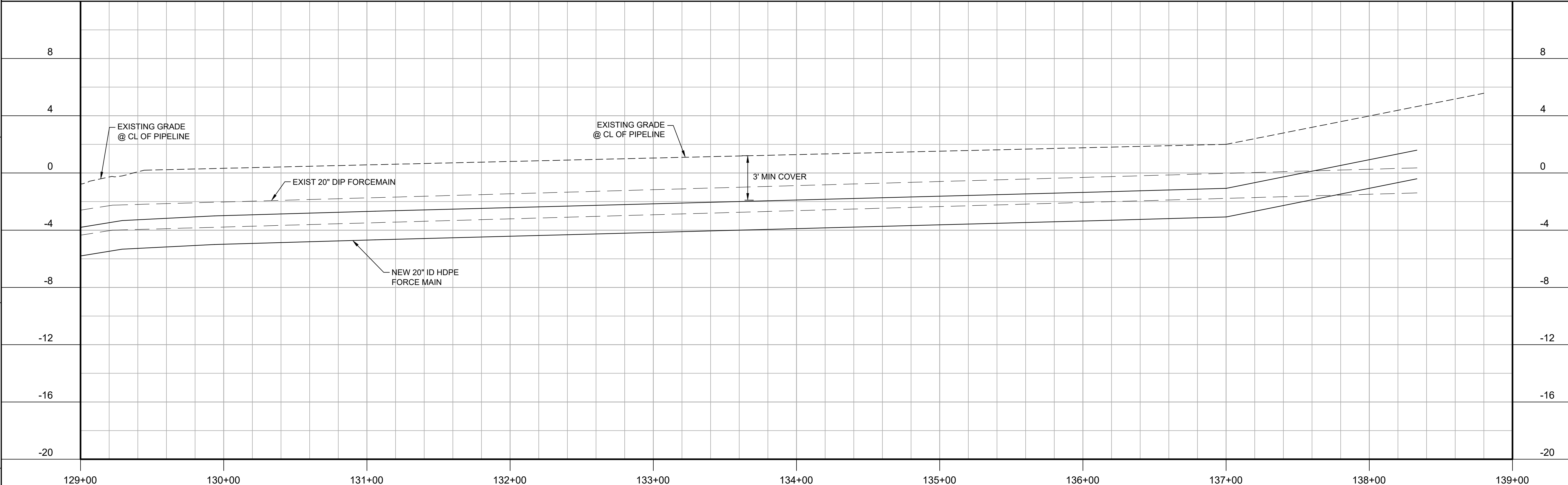
Know what's below.  
Call before you dig.

- GENERAL NOTES:**
- 50' FROM CL OF NEW 20" ID HDPE FORCE MAIN (FM) PIPE TO EXISTING 20" DIP FORCE MAIN.
  - EXISTING 20" DIP FM SHOWN IN PROFILE AS REFERENCE ONLY.
  - THE EXISTING FORCE MAIN IS TO REMAIN IN PLACE FOR FUTURE CONDITION ASSESSMENT AND POTENTIAL REHABILITATION. AFTER REHABILITATION, EXISTING FORCE MAIN MAY BE USED AS A REDUNDANT FORCE MAIN OR FOR BRINGING RECLAIMED WATER TO THE TOWN.

- KEY NOTES:**
- THIS DIMENSION IS APPROXIMATE DUE TO THE VARIANCE OF THE EXISTING FORCE MAIN.

**LEGEND**

- FM — EXISTING FORCE MAIN
- ===== PROPOSED FORCE MAIN
- - - - CONSTRUCTION LIMITS
- LIMITS OF JURISDICTIONAL WETLANDS
- ~ ~ ~ ~ SHEET PILE
- ⊗ ⊗ ⊗ ⊗ TURBIDITY CURTAIN
- NON-VEGETATED BAY BOTTOM
- PATCHY SEAGRASS
- CONTINUOUS SEAGRASS
- OYSTERS
- INTERTIDAL WETLAND (MANGROVES)
- FRESHWATER WETLAND
- UPLANDS
- SEAGRASS RESTORATION FILL AREAS
- RIPRAP



**KEY MAP**

**SCALE**

0 20' 40' 80'  
SCALE: 1" = 40' (HORIZ)

0 5' 10' 20'  
SCALE: 1" = 10' (VERT)

**PERMIT PLANS  
NOT FOR CONSTRUCTION**

REV	DATE	BY	DESCRIPTION
1			
2			

DESIGNED MAF  
DRAWN BWH  
CHECKED SR  
DATE DECEMBER 2021

Digitally signed by Matthew Scott Richards  
Contact Info: Carollo Engineers, Inc.  
Date: 2021.12.17 14:44:28-0500



TOWN OF LONGBOAT KEY  
ENVIRONMENTAL PERMITTING FOR  
SUBAQUEOUS FORCE MAIN  
CIVIL  
PLAN AND PROFILE  
STA 129+00 TO 138+34±

**VERIFY SCALES**

BAR IS ONE INCH ON ORIGINAL DRAWING

0 1" 1"

IF NOT ONE INCH ON THIS SHEET, ADJUST SCALES ACCORDINGLY

JOB NO. 11006H.10
DRAWING NO. <b>C12</b>
SHEET NO. 13 OF 15



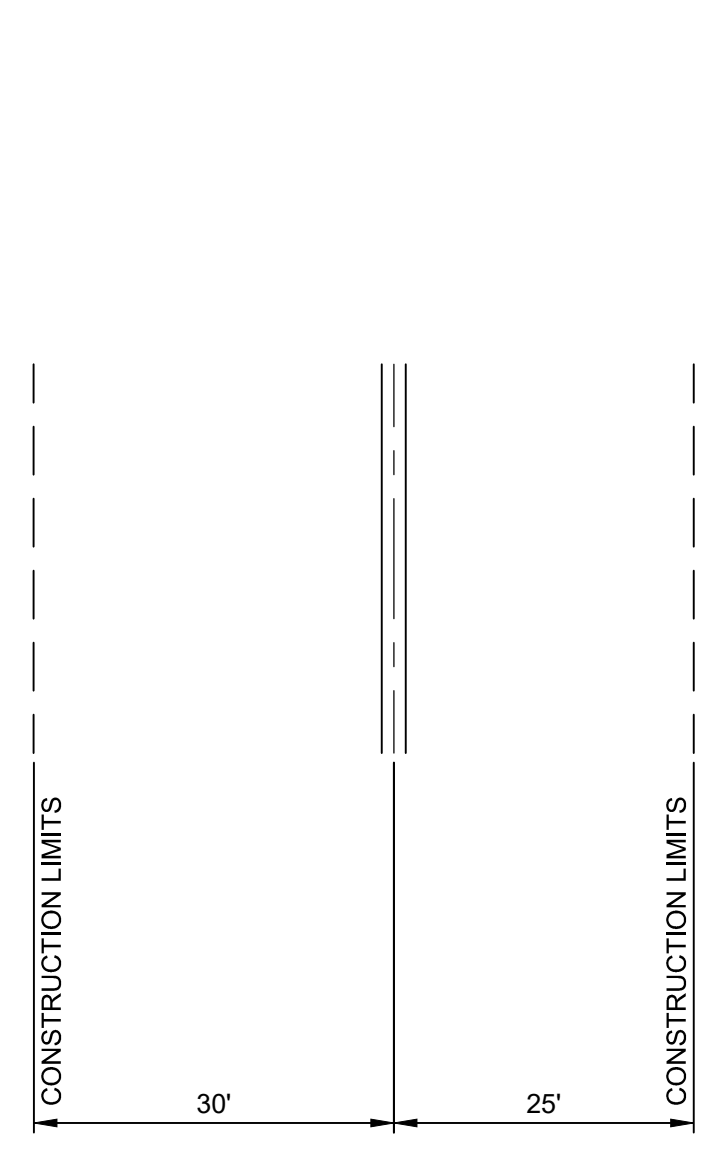
Plot Date: 12/16/2021 2:06:51 PM

FILE NAME: 11006H10CD01.dwg

PROJECT NO.: 11006H10

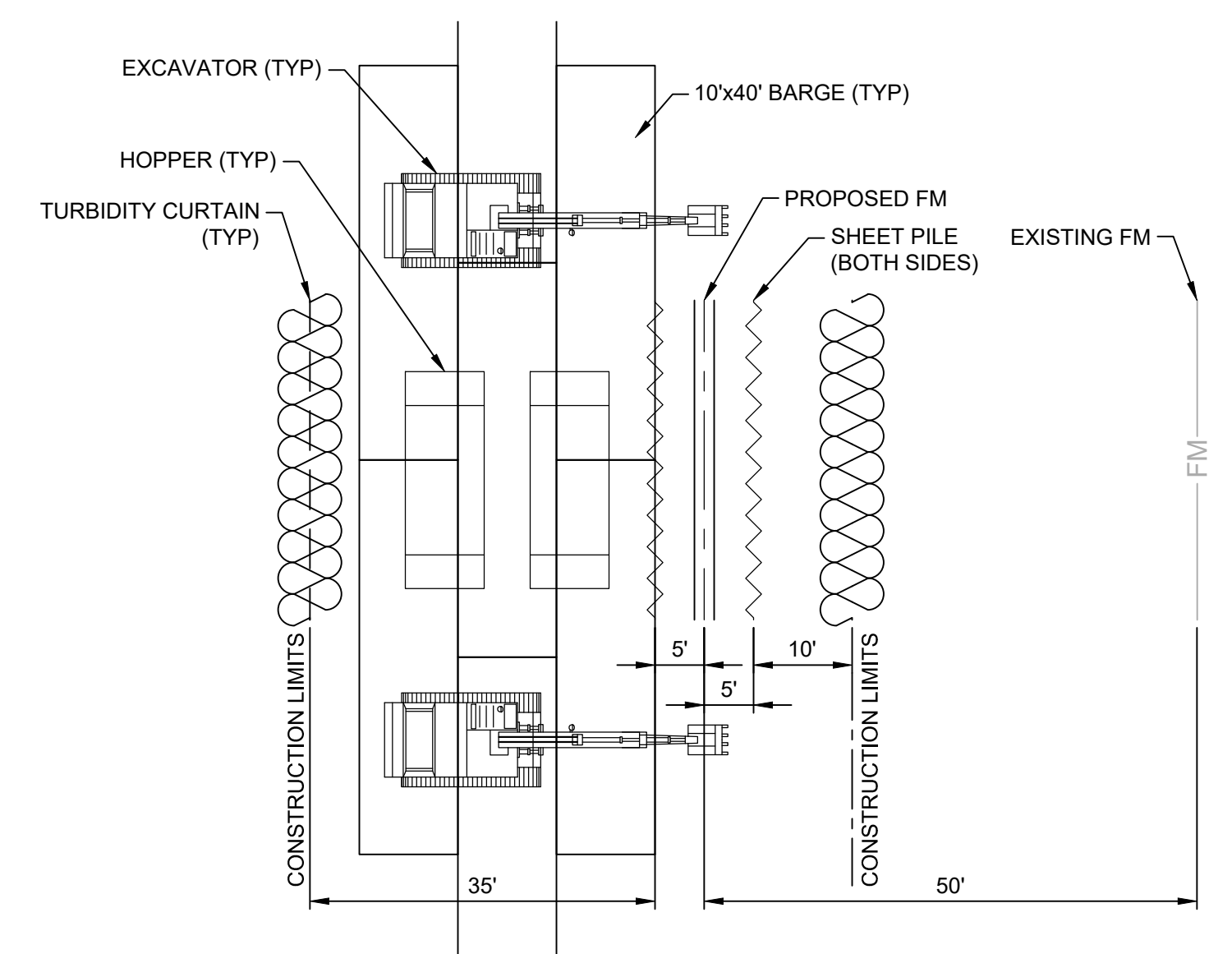
LAST SAVED BY: bbraves

- GENERAL NOTES:**
- BARGES WILL NOT DISTURB SEAGRASS IN >4' OF WATER.
  - SECTION LIMITS ARE SHOWN IN THE DRAWINGS.



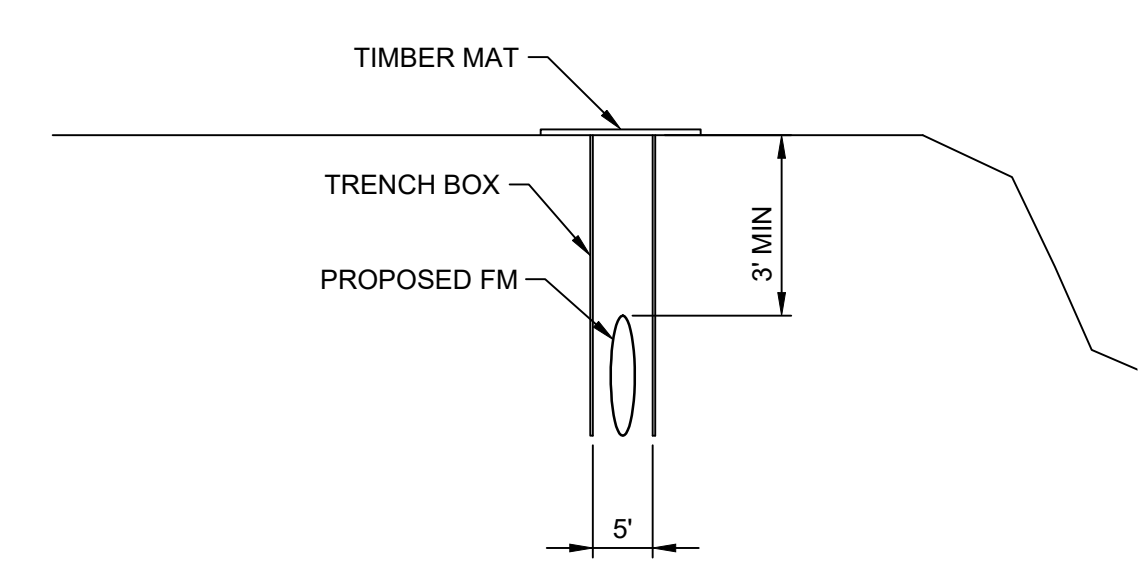
**PLAN**

**A WEST UPLAND**  
C01 SCALE: AS NOTED

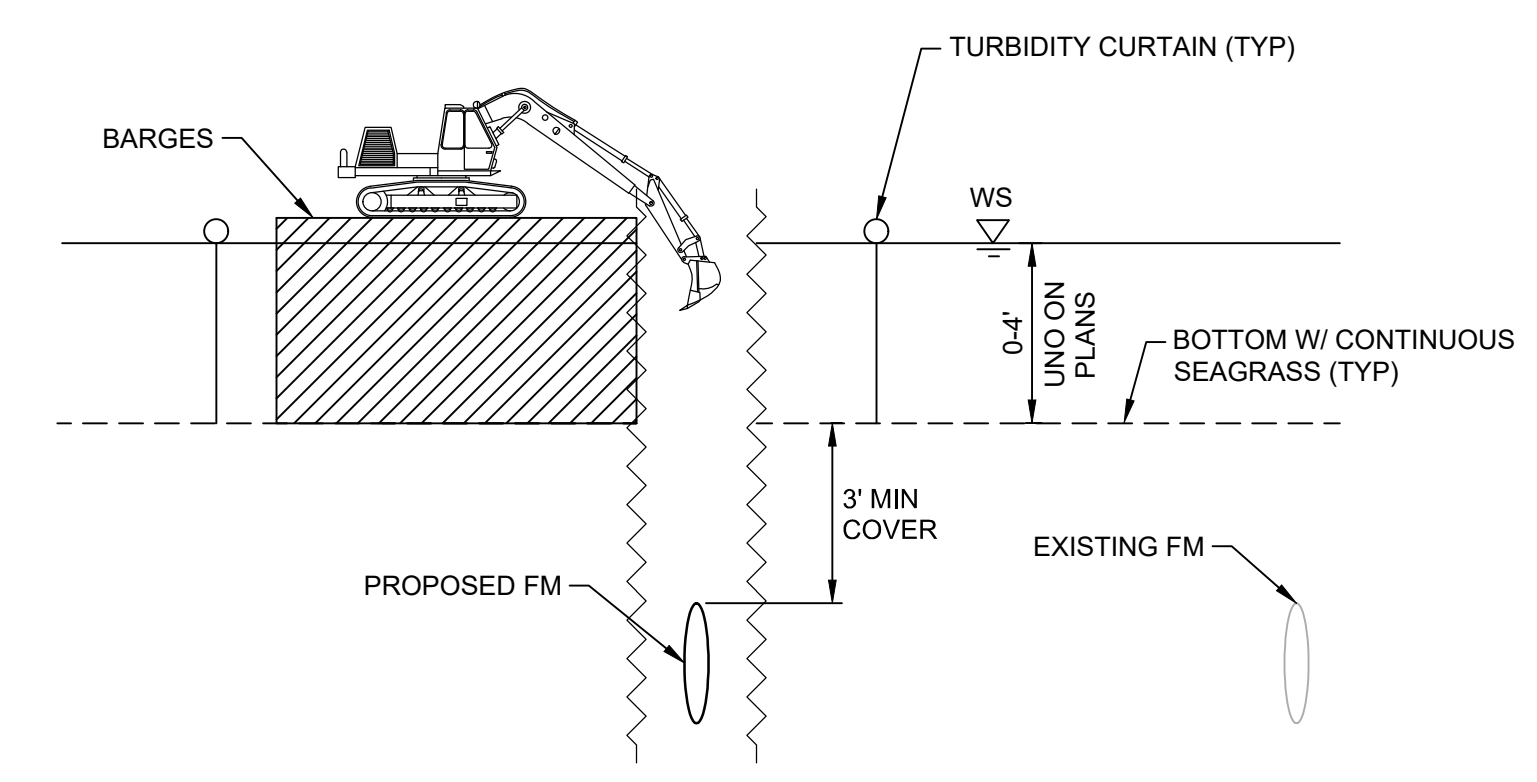


**PLAN**

**B EAST AND WEST ENDS**  
C01 C02 C10 C11 SCALE: AS NOTED

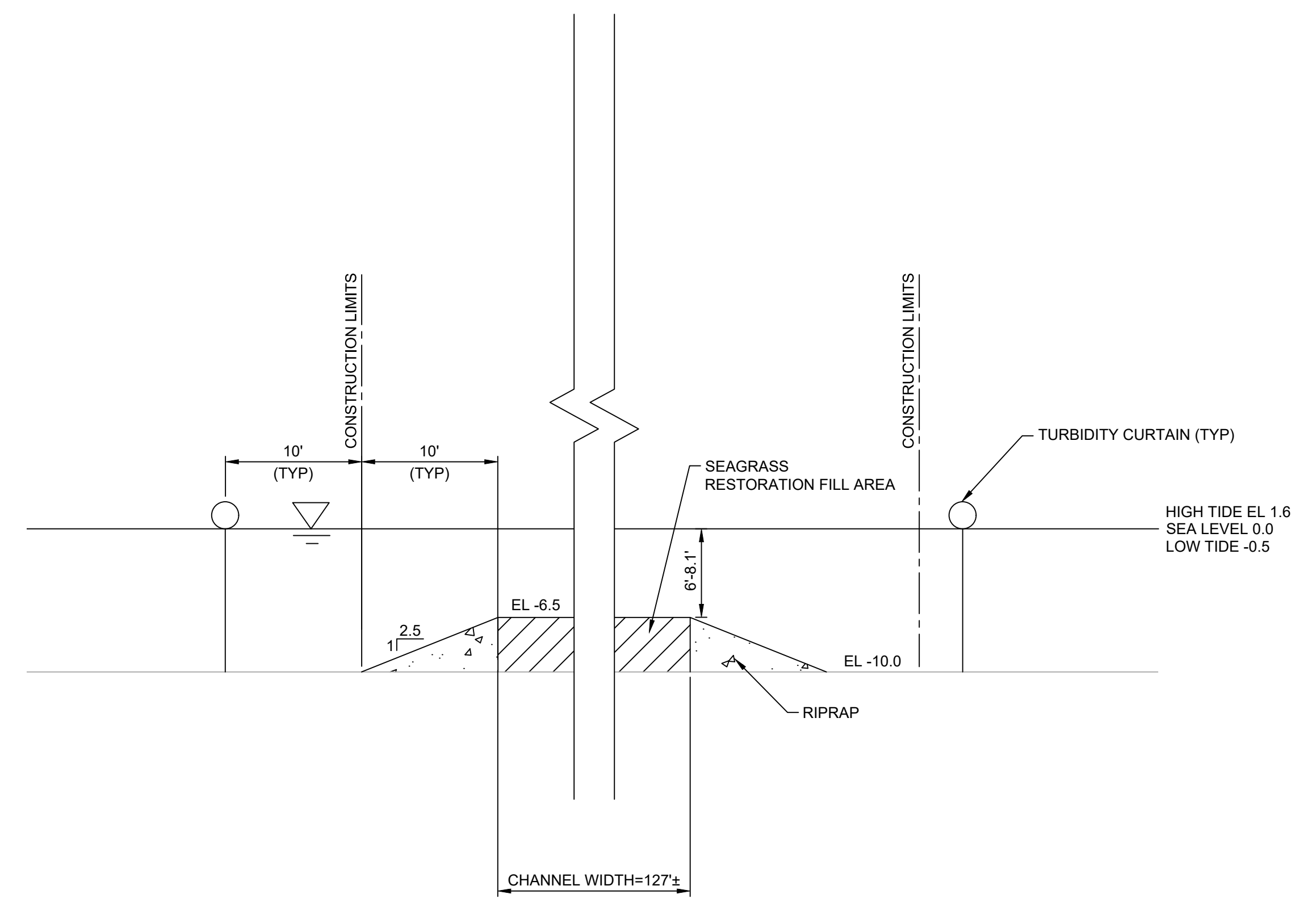


**SECTION**

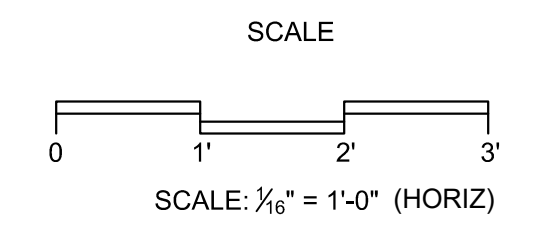


**SECTION**

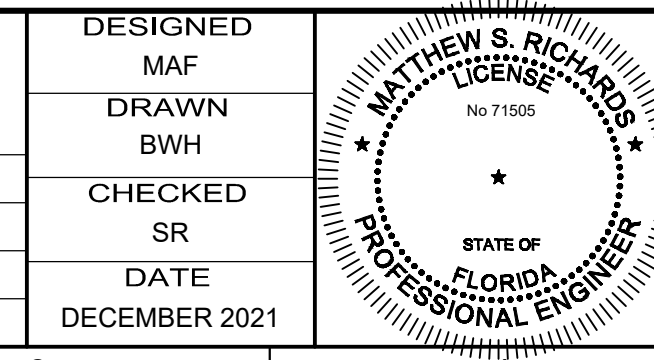
NOTE: THE CONSTRUCTION LAYOUT SHOWN IS FOR GRAPHICAL PURPOSES ONLY. ACTUAL CONSTRUCTION LAYOUT TO BE DETERMINED BY THE SELECTED DESIGN-BUILDER OR CONTRACTOR AND MUST BE WITHIN THE LIMITS SHOWN IN THE DETAIL.



**E UNNAMED CHANNEL**  
C07 SCALE: 1/8" = 1'-0"



<b>PERMIT PLANS NOT FOR CONSTRUCTION</b>			
DESIGNED MAF	DRAWN BWH	CHECKED SR	DATE DECEMBER 2021
REV	DATE	BY	DESCRIPTION



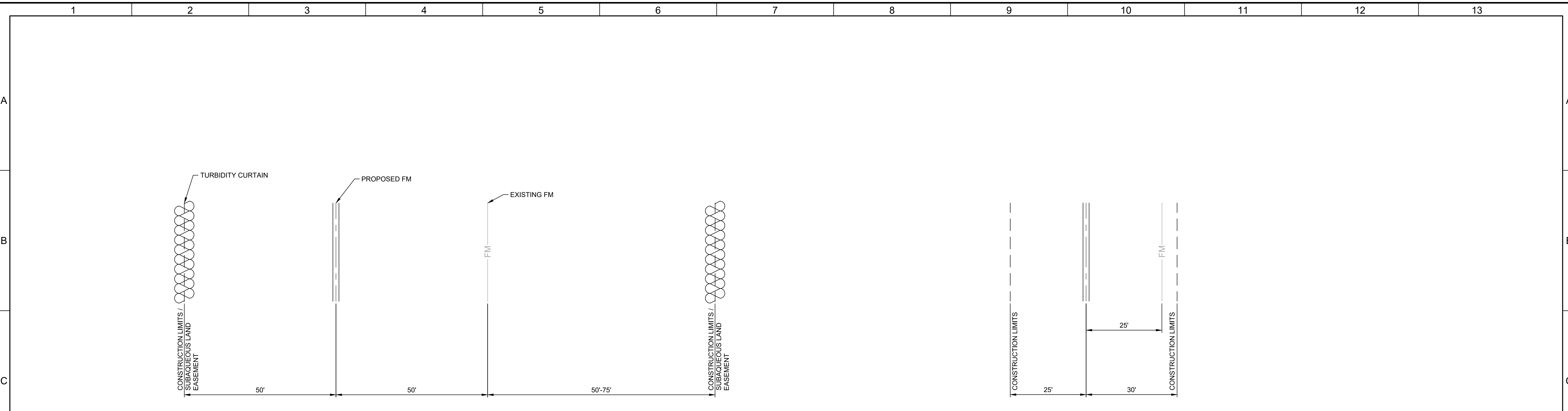
Digitally signed by Matthew Scott Richards  
Contact Info: Carollo Engineers, Inc.  
Date: 2021.12.17 14:40:24-0500

*Matthew Scott Richards*



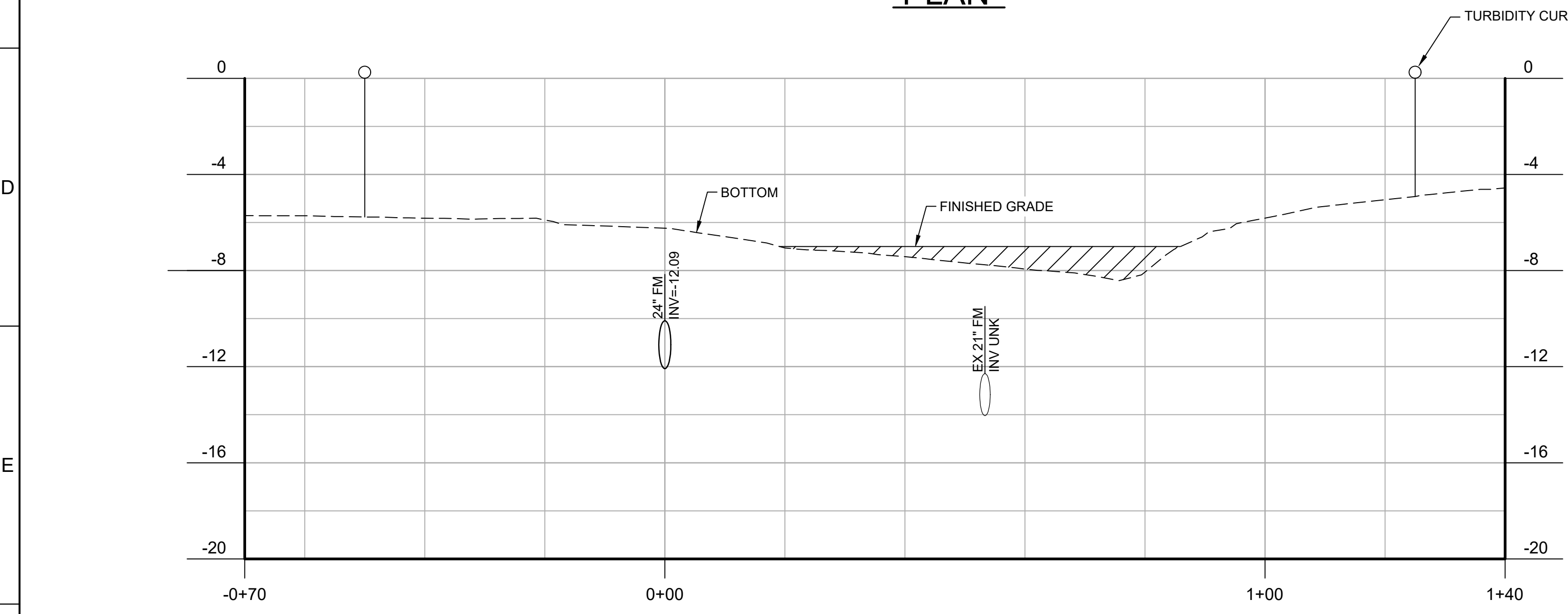
TOWN OF LONGBOAT KEY  
ENVIRONMENTAL PERMITTING FOR  
SUBAQUEOUS FORCE MAIN  
CIVIL  
**SECTIONS 1**

VERIFY SCALES BAR IS ONE INCH ON ORIGINAL DRAWING 0 1 2 3 IF NOT ONE INCH ON THIS SHEET, ADJUST SCALES ACCORDINGLY	JOB NO. 11006H.10 DRAWING NO. <b>CD01</b> SHEET NO. 14 OF 15
---	---



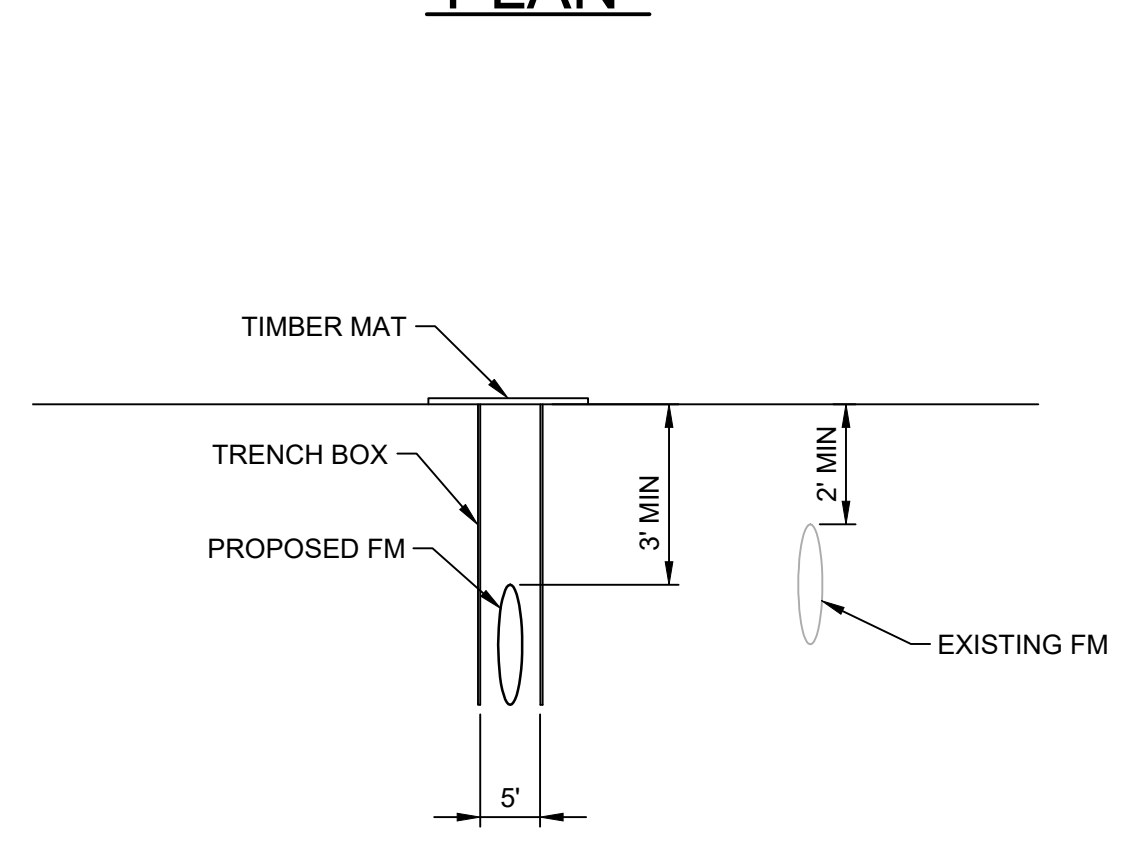
PLAN

PLAN



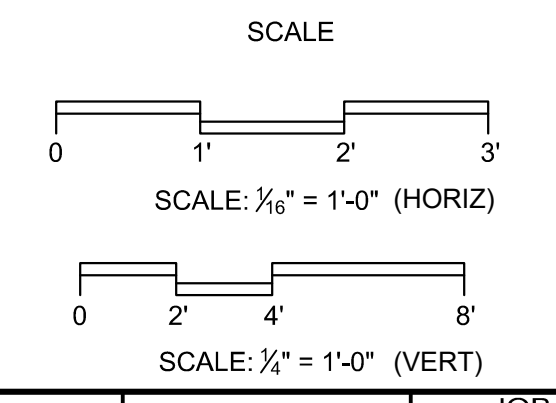
TYPICAL SECTION

C CENTER POSITION  
SCALE: AS NOTED

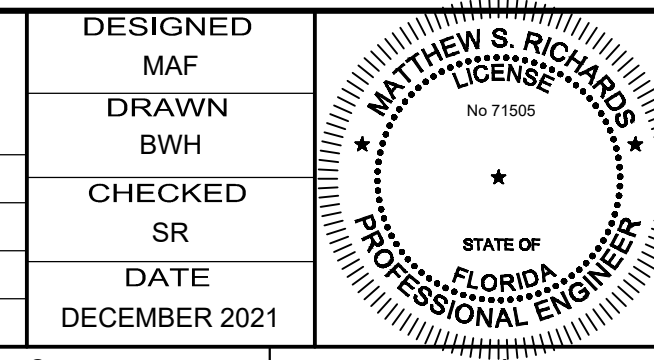


SECTION

D EAST UPLAND  
SCALE: AS NOTED



PERMIT PLANS NOT FOR CONSTRUCTION			
DESIGNED MAF	DRAWN BWH	CHECKED SR	DATE DECEMBER 2021
REV	DATE	BY	DESCRIPTION



Digitally signed by Matthew Scott Richards  
 Contact Info: Carollo Engineers, Inc.  
 Date: 2021.12.17 14:40:04-0500

*Matthew Scott Richards*



TOWN OF LONGBOAT KEY  
 ENVIRONMENTAL PERMITTING FOR  
 SUBAQUEOUS FORCE MAIN  
 CIVIL  
 SECTIONS 2

VERIFY SCALES BAR IS ONE INCH ON ORIGINAL DRAWING 0 1 2 4 8 IF NOT ONE INCH ON THIS SHEET, ADJUST SCALES ACCORDINGLY	JOB NO. 11006H.10 DRAWING NO. CD02 SHEET NO. 15 OF 15
---	--

Final

# LONGBOAT KEY SUBAQUEOUS FORCE MAIN Mitigation Plan Document

Prepared for  
Town of Longboat Key

Revised December 2021





Final

# LONGBOAT KEY SUBAQUEOUS FORCE MAIN Mitigation Plan Document

Prepared for  
Town of Longboat Key  
Under Subcontract to Carollo Engineers

Revised December 2021

4200 West Cypress Street  
Suite 450  
Tampa, FL 33607  
813.207.7200  
esassoc.com



Bend	Orlando	San Jose
Camarillo	Pasadena	Santa Monica
Delray Beach	Petaluma	Sarasota
Destin	Portland	Seattle
Irvine	Sacramento	Tampa
Los Angeles	San Diego	
Oakland	San Francisco	

# TABLE OF CONTENTS

## Longboat Key Subaqueous Force Main Mitigation Plan Document

	<u>Page</u>
<b>1.0 Introduction.....</b>	<b>1</b>
1.1 Project Background.....	1
1.2 Project Purpose and Need.....	4
1.3 Alternatives Analysis.....	4
1.3.1 Alignment Alternatives.....	4
1.3.2 Construction Alternatives.....	5
1.4 Proposed Construction Approach.....	6
1.5 Project Impacts.....	9
<b>2.0 Mitigation Plan.....</b>	<b>11</b>
2.1 Objectives.....	11
2.2 Site Selection.....	11
2.3 Site Protection Instrument.....	13
2.4 Baseline Information.....	13
2.4.1 Freshwater Wetlands.....	14
2.4.2 Mangroves and Tidal Flats.....	14
2.4.3 Seagrasses.....	14
2.4.4 Oysters.....	17
2.5 Determination of Credits.....	17
2.6 Mitigation Work Plan.....	17
2.6.1 Component 1 – Freshwater Wetlands.....	17
2.6.2 Component 2 – Mangroves and Tidal Flats.....	20
2.6.3 Component 3 – Seagrasses.....	21
2.6.4 Component 4 – Oysters.....	22
2.7 Maintenance Plan.....	23
2.7.1 Component 1 – Freshwater Wetlands.....	23
2.7.2 Component 2 – Mangroves and Tidal Flats.....	23
2.7.3 Component 3 – Seagrasses.....	24
2.7.4 Component 4 – Oysters.....	24
2.8 Performance Standards.....	24
2.9 Monitoring Requirements.....	25
2.10 Long-Term Management Plan.....	26
2.10.1 Component 1 – Freshwater Wetlands.....	26
2.10.2 Component 2 – Mangroves and Intertidal Habitats.....	26
2.10.3 Component 3 – Seagrasses.....	26
2.10.4 Component 4 – Oysters.....	27
2.11 Adaptive Management Plan.....	27
2.12 Financial Assurances.....	27

Page**List of Figures**

Figure 1-1 Repair of Existing Force Main Within Mangroves.....	3
Figure 1-2 Existing Force Main Alignment (Alignment 1).....	5
Figure 1-3 Project Segmentation Scheme .....	6
Figure 1-4 Construction Limits and Methods in Segment 1 .....	7
Figure 1-5 Construction Limits and Methods in Segment 2 .....	8
Figure 1-6 Construction Limits and Methods in Segments 2 and 4 .....	8
Figure 1-7 Construction Limits and Methods in Segment 3 .....	9
Figure 2-1 Longboat Key Mitigation Plan .....	12
Figure 2-2 Seagrass Acreage Trends in Northern Sarasota Bay .....	15
Figure 2-3 Seagrass Coverage Within the Project Limits 2017-2020 .....	16

**List of Tables**

Table 1-1 Summary of Project Impacts to Wetlands and Submerged Habitats .....	10
Table 2-1 Summary of Mitigation Plan Objectives and Compensation Methods.....	11
Table 2-2 Town of Longboat Key Redundant Subaqueous Sewer Force Main UMAM Summary (Revised December 2021) .....	18
Table 2-2 Summary of Maintenance Plan Components .....	24
Table 2-3 Proposed Performance Standards.....	25



# LONGBOAT KEY SUBAQUEOUS FORCE MAIN

---

## Mitigation Plan Document

### 1.0 Introduction

#### 1.1 Project Background

Currently, domestic wastewater from the barrier island Town of Longboat Key (Town) is collected and pumped, via Lift Station D, to the mainland for treatment at the Manatee County Southwest Regional Water Reclamation Facility (SWRWRF). The wastewater is transported via a 20-inch inner diameter (ID) ductile iron pipe (DIP) force main that was constructed in 1973 and placed into operation in 1975. This pipeline is the sole mode of wastewater transmission from the barrier island to the mainland and has been in continuous service for 45 years. When constructed, the service life is considered to be 50 years. The existing force main was constructed using barge mounted equipment that excavated an open trench along the bottom of Sarasota Bay, laid the pipe in the trench, and then buried the pipe with the excavated material. Upon project completion, an as-built survey was completed.

The subaqueous force main provided decades of service without any known incidents of leakage or failure. However, due to concerns about the age of the force main, the Town began conducting inspections of the subaqueous pipeline to determine the depth of the bury and the general external condition of the ductile iron pipe. Inspections were conducted in 1992, 1996, 2007, and 2011. In 2015 the Town conducted an internal Smart Ball® pipe wall assessment of the force main interior condition to determine the pipe wall thickness and degree of corrosion. The conclusions derived from the external inspections were that the force main was generally in good condition with sufficient bury depth (e.g., 2 foot minimum); while the 2017 internal inspection concluded that the pipe wall thickness was sufficient to provide another 20-25 years of service.

Given the age of the force main, the Town contracted with CDM Smith in 2015 to evaluate five alternative alignments (routes), including the existing alignment, as well as various pipe materials and alternative construction approaches for replacing the existing force main (CDM Smith/Laney, 2015). A total of 90 scenarios (alignment + pipe material + construction approach) were identified. After an initial feasibility screening, the list of scenarios was reduced to 44. These various scenarios were ranked pursuant to a range of criteria.

The highest ranked scenario was the existing alignment (Alignment 1) using a single pull Horizontal Directional Drill (HDD). However, these conclusions were qualified, contingent upon the determination of suitable geotechnical conditions in the subaqueous portion of the alignment,

as well as the technical feasibility of conducting a single pull HDD under the 2.3 mile crossing of Sarasota Bay. At the time of this writing, the 2.3-mile crossing of Sarasota Bay would be longest HDD single pull subaqueous project in the U.S., testing the limits of this technology.

Due to concerns about the suitable geotechnical conditions, technical feasibility, failure risks, and cost of the HDD construction approach, the Town contracted with Carollo Engineers (Carollo) and Environmental Science Associates (ESA) in 2017 to initiate discussions with the Florida Department of Environmental Protection (FDEP) and the U.S. Army Corps of Engineers (USACE) to assess the permitability of an open cut construction approach to install a redundant force main adjacent to the existing force main. Based on the feedback received from the FDEP and USACE in these meetings, ESA conducted an environmental assessment of the marine resources at risk in the existing alignment - including seagrasses, mangroves, and oysters (ESA, 2019).

In 2019 Carollo and ESA conducted pre-application meetings with the FDEP and the USACE, during which the findings of the environmental assessment were presented, and the intent to pursue an open cut construction approach within the existing alignment was discussed. Feedback was received from both agencies with respect to the need to conduct an alternatives analysis, and to select an alignment and construction approach that best avoids and/or minimizes environmental impacts and risks.

On June 29, 2020, a sewage leak was discovered within the mangrove fringe along the east side of the existing force main alignment in Manatee County, approximately 350 feet from the open waters of Sarasota Bay, underneath fringing mangroves. The cause of the leak appeared to be corrosion of the buried pipe where it was found to be in contact with a log or tree stump.

The leak was quickly contained and repaired, and the volume of sewage that was discharged to the environment was determined to be approximately 14 million gallons. To gain access to repair the leak a dirt haul road had to be constructed into the mangroves (see **Figure 1-1**). In addition, the discharge of raw sewage resulted in the die off of mangroves due to hydrologic stress. In total, the sewage leak and the road fill impacts resulted in 1.43 acres of impacts to mangroves and fringe freshwater wetlands.

On February 22, 2021 the Town of Longboat Key executed a Consent Order with the FDEP to address restoration of the mangrove and freshwater wetland impacts, as well as other measures to prevent future leaks, and to respond in a timely and effective manner if another leak occurs. The June 2020 leak has elevated concerns about the condition and remaining service life of the existing force main, thus creating a need to further explore the construction of a new redundant force main at this time.



**Figure 1-1**  
Repair of Existing Force Main Within Mangroves

In October 2020, the Town of Longboat Key submitted permit applications to both the FDEP and USACE for a new redundant sewer force main, proposing an open cut trench construction approach. A *Permit Support Document* (Carollo Engineers/ESA) was included as part of the permit applications submittals. That document provided: a summary of the alternatives analysis conducted by the Carollo/ESA consultant team; a summary of the proposed open-cut construction approach for the preferred alignment; a description of existing environmental conditions; quantification of temporary impacts to aquatic resources; and a narrative discussion of the proposed conceptual mitigation approach to compensate for those impacts.

This *Longboat Key Redundant Force Main Mitigation Plan* document has been prepared to provide a detailed description of the various proposed mitigation components for the project in response to agency Requests for Additional Information. The mitigation plan described herein addresses the 12 elements of a mitigation plan, as required under 40 CFR Part 230 *Compensatory Mitigation for Losses of Aquatic Resources; Final Rule*, promulgated by the U.S. Environmental Protection Agency in 2008. In addition to this document, construction plans for the proposed mitigation components are provided as part of the revised *Permit Plans* set, submitted concurrently.

## 1.2 Project Purpose and Need

The purpose of the proposed project is to construct a redundant domestic wastewater force main adjacent to, and north of, the existing force main. Given the approaching end of the projected service life of the existing force main, and the recently discovered and repaired sewage leak, there is a high degree of urgency to obtain permits to allow the Town the ability to complete this critical infrastructure project expeditiously.

Given that there are very limited options for conveying domestic sewage flows to the wastewater treatment plant should there a failure of existing sewer force main, the construction of a new redundant force main is a high priority infrastructure project needed to reduce the risk of future sewage leaks, to provide additional and redundant flow capacity, and to potentially facilitate the return of reclaimed water to Longboat Key to support regional potable water conservation initiatives.

## 1.3 Alternatives Analysis

In October 2020, the Town of Longboat Key submitted permit applications to both the FDEP and USACE for a new redundant sewer force main, proposing an open cut trench construction approach. The *Permit Support Document* (Carollo Engineers/ESA) was provided as part of the permit applications submittals. This document included a detailed alternatives analysis.

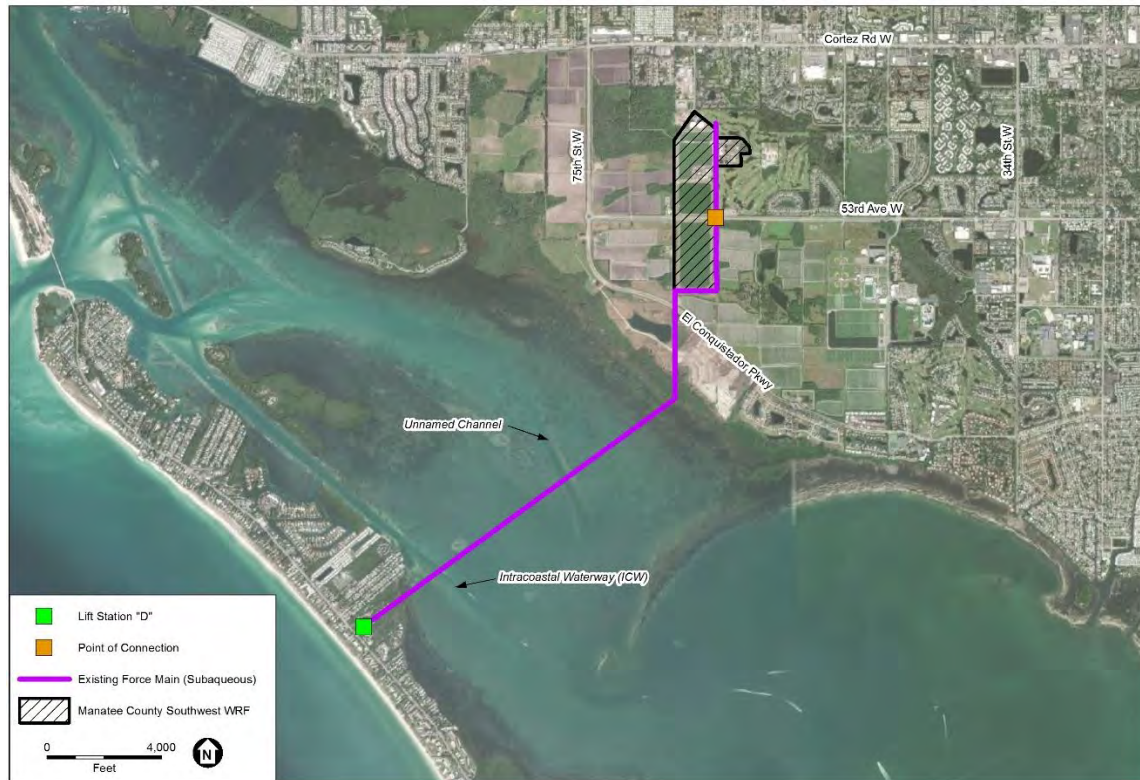
### 1.3.1 Alignment Alternatives

The alternatives analysis evaluated several subaqueous alignments, including the alignment of the existing force main (Alignment 1), as well as an upland alignment (Alignment 5). The other subaqueous alignments would all involve new impacts to previously unimpacted wetlands and submerged habitats, and were eliminated from further consideration accordingly. Alignment 5 would involve the construction of a new pipeline and pump stations northward across Longboat Pass to Bradenton Beach, and then across Sarasota Bay along the Cortez Road bridge corridor to the Manatee County SWRWRF. Given that impacts to aquatic resources would likely be reduced, this alignment was evaluated for feasibility.

Constructing a new force main along Alignment 5 would require substantial modifications to the Town's existing wastewater infrastructure. In addition, Alignment 5 poses numerous and extensive engineering and public impact constraints, including: ROW limitations; hydraulic constraints; utility and roadway conflicts; increased operation and maintenance requirements; traffic disruptions; odor; and overall public opposition. Given concerns about the recent leak and the remaining service life of the existing force main, the construction of a redundant force main is a critical and urgent priority infrastructure project. All of these issues cumulatively make Alignment 5 infeasible with respect to schedule as well as budget.

Based on the CDM Smith/Laney (2015) alignment analysis, and the evaluations presented in the *Permit Support Document*, Alignment 1 is clearly the preferred alignment. The Town's wastewater infrastructure has been designed and constructed over the years to collect and pump domestic sewage to existing Lift Station D, and to pump all collected sewage from this lift station to the Manatee County SWRWRF through the existing subaqueous force main. Alignment 1 is a

long-established and previously impacted utility corridor which encompasses the existing force main; and could accommodate the construction of a redundant force main parallel to the existing force main with minimal new environmental impacts. The location and alignment of the existing and proposed new force main is shown in **Figure 1-2** below.



**Figure 1-2**  
Existing Force Main Alignment (Alignment 1)

### 1.3.2 Construction Alternatives

The highest ranked construction alternative for Alignment 1 was Alternative 1 (All Open-Cut Trench), followed by Alternatives 5 (Hybrid 3) and Alternative 6 (Hybrid 4). Alternatives 5 and 6 both involve trenchless construction approaches (e.g., horizontal directional drill) on the western end of the project that would avoid surface impacts west of the Intra-Coastal Waterway (ICW). However, four of the eight hybrid alternatives evaluated were eliminated due to the fatal engineering flaw of having high points in the force main transmission line that would require an air release valve (ARV) be installed in Sarasota Bay, which would require frequent maintenance and pose high failure and leak risks. Furthermore, all of the trenchless construction approaches have the additional risk of frac-outs, or the collapse of the bore hole and the discharge of drilling fluids into overlying surface waters.



Given that the open-cut trench construction approach is the most proven construction method that meets all other engineering specifications, Alternative 1 was chosen as the preferred construction alternative for the proposed project. The full alternatives analysis is presented in the *Permit Support Document* (Carollo Engineers/ESA, 2020).

While Alternative 1 (All Open-Cut Trench) does have the greatest impacts to wetlands and submerged habitats, it must be emphasized here that any and all impacts to these resources caused by the proposed project are associated with project construction only. No components of the proposed project will result in a permanent loss of any ecological resources within Alignment 1; therefore, all impacts are considered to be temporary. Furthermore, the proposed construction approach has been developed to avoid and minimize impacts to wetlands and submerged habitats to the greatest extent feasible.

## 1.4 Proposed Construction Approach

As proposed, the redundant force main will be constructed of 20-inch ID High Density Polyethylene (HDPE) pipe, which is impervious to corrosion and is highly resilient, thus making it ideal for applications in the marine environment. The proposed new force main will be constructed adjacent to, and 50 feet north (in most segments) of the existing force main using an open cut trench construction approach. Upon completion of the new force main, the existing force main may be rehabilitated by lining it with a smaller diameter HDPE pipe, upon which it can be used as a redundant sewage line, or used for the return of the highly treated reclaimed water back to Longboat Key to offset the use of potable water for irrigation.

During construction, direct physical impacts to the surface area of the bay bottom, as well as to the mangrove fringe on both ends of the project, will be minimized through tight confinement of the work areas. Secondary impacts caused by turbidity will be stringently controlled and minimized by using sheet piling, shoring, and turbidity screens. The project construction corridor along Alignment 1 can be broken down into five segments based on ground conditions and water depth, as shown in **Figure 1-3**.

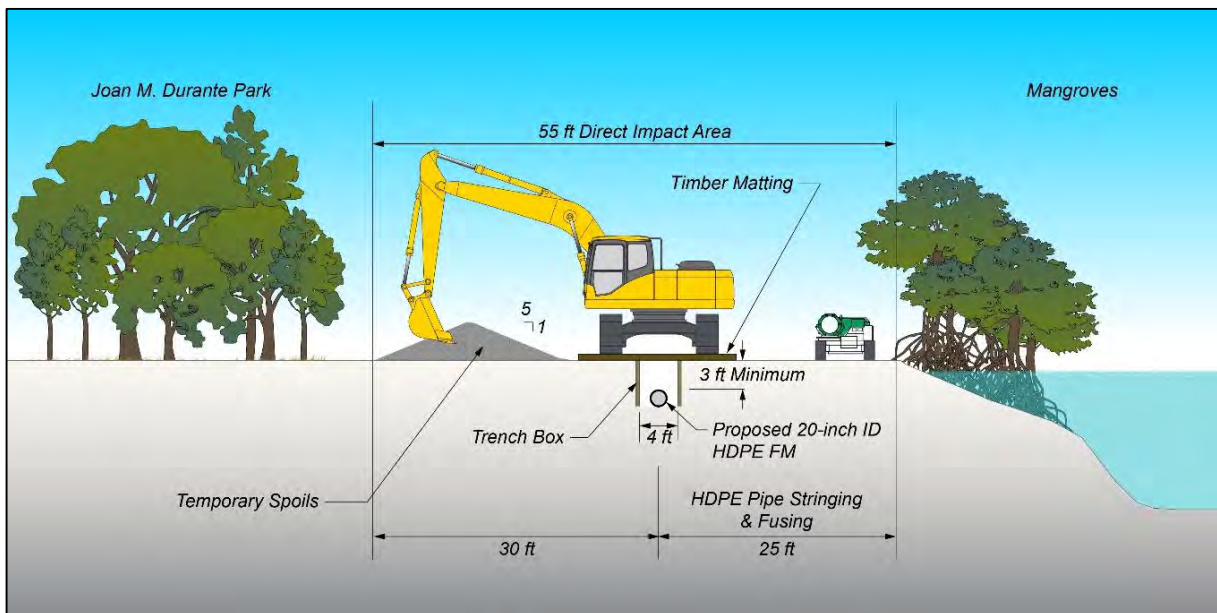


**Figure 1-3**  
Project Segmentation Scheme

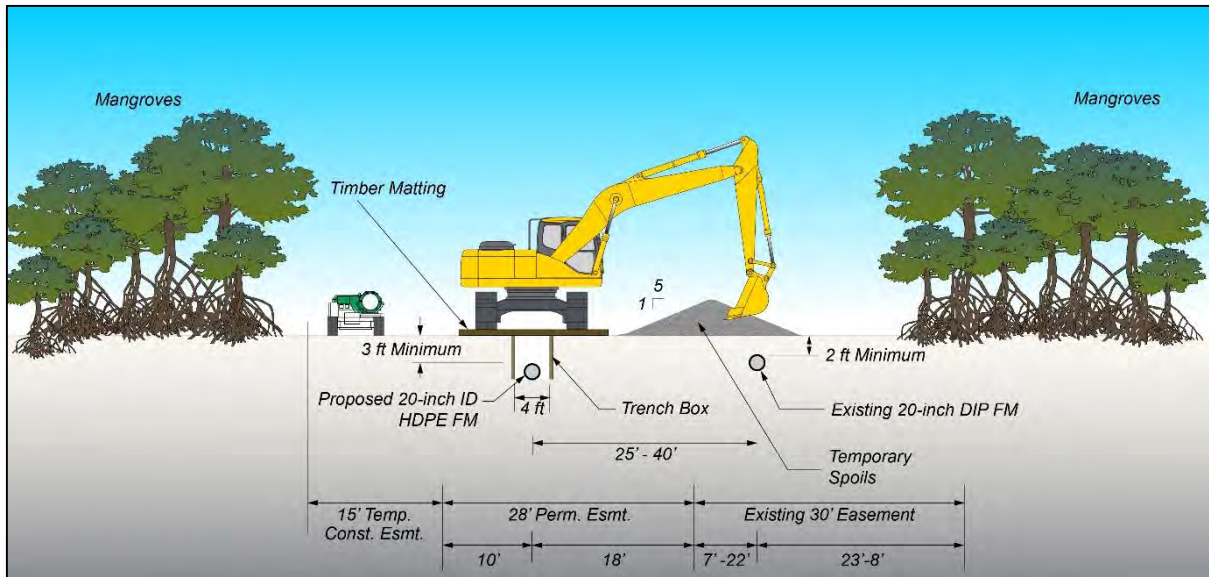
The project construction limits and methods vary in each of the five segments based on ground conditions, water depth and other constraints such as existing easements and public facilities. It should be noted that the extent of impacts has been reduced from the initial permit application submittals, as the project construction limits and methods were subsequently revised to further minimize impacts to wetlands and submerged habitats. Specifically, the project construction cross-section widths were reduced in Segments 1, 2, 4, and 5 compared to the initial *Permit Plans* set. The following figures show the construction limits and methods to be used in the five project segments.

**Figure 1-4** and **Figure 1-5** show the typical construction limits and proposed construction methods for Segment 1 (west end intertidal/upland zone) and Segment 5 (east end intertidal/upland zone), respectively.

In both Segments 1 and 5, earthmoving equipment will be used to dig the trench, install the trench box and pipe material, and to bury the new force main. Spoils will be temporarily stockpiled immediately adjacent to the trench cut, and then placed back into the trench. Following construction, all disturbed work areas will be restored back to pre-construction topographic elevations, and re-planted with mangroves and/or freshwater wetland species, as described in Section 2.

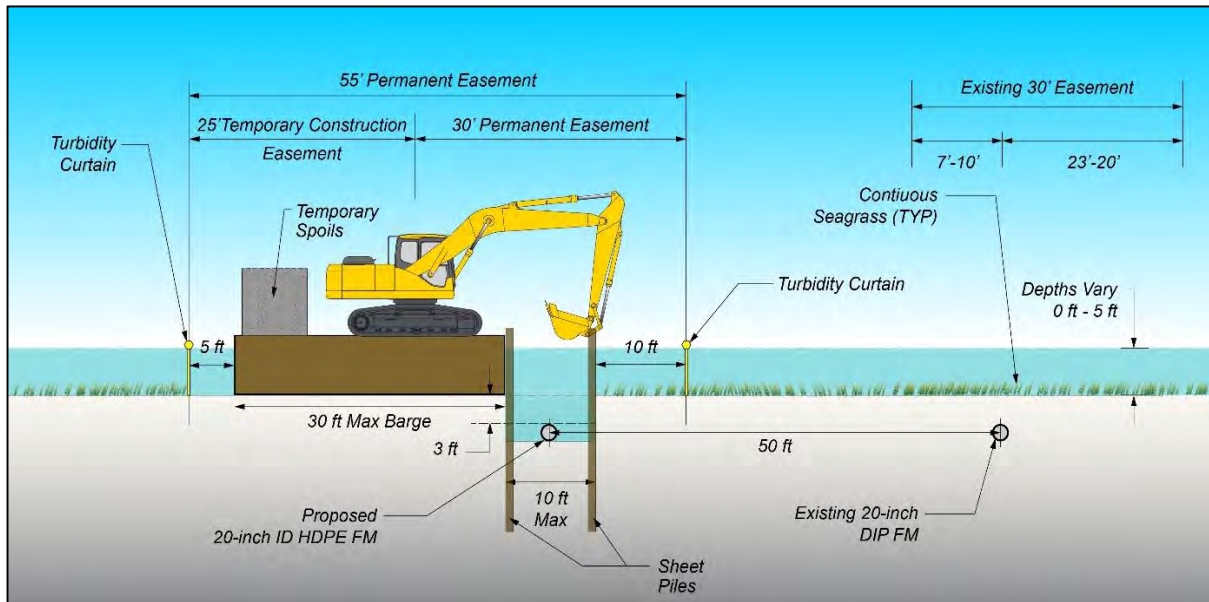


**Figure 1-4**  
Construction Limits and Methods in Segment 1



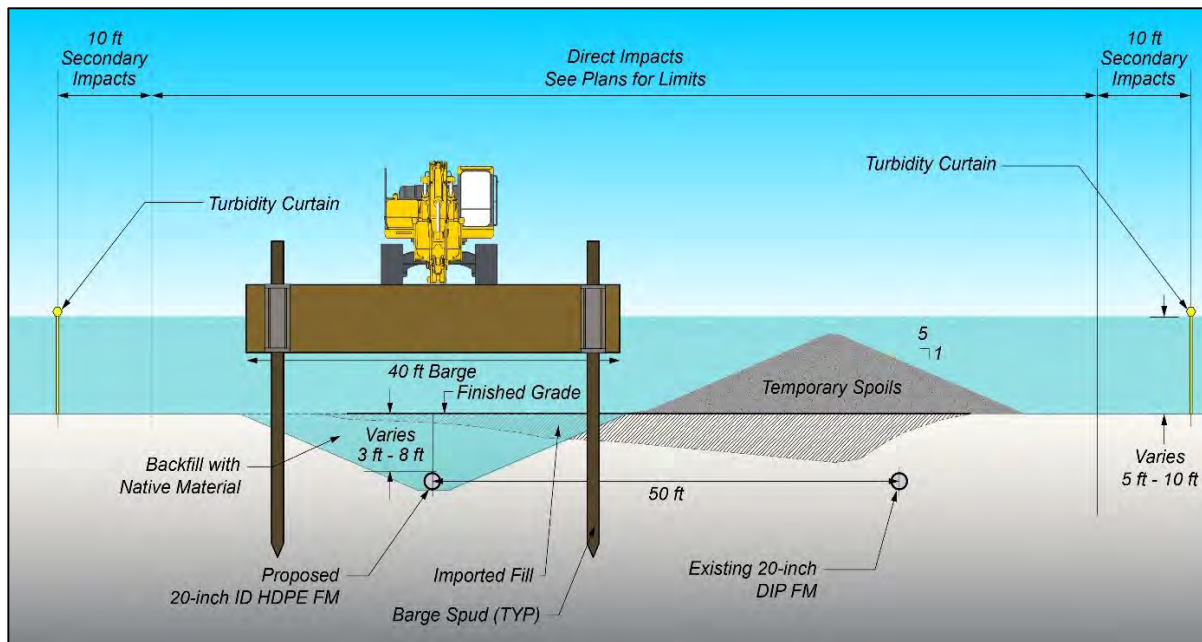
**Figure 1-5**  
Construction Limits and Methods in Segment 2

**Figure 1-6** shows the typical construction limits and proposed construction methods for Segments 2 and 4 (shallow subtidal zones). In Segments 2 and 4, barge mounted earthmoving equipment will be used to dig the trench, install the pipe material, and to bury the new force main. Spoils will be temporarily stockpiled in the barge-mounted hoppers with fluid containment and turbidity controls, and then placed back into the trench. Following construction, all disturbed work areas will be restored back to pre-construction bathymetric elevations.



**Figure 1-6**  
Construction Limits and Methods in Segments 2 and 4





**Figure 1-7**  
Construction Limits and Methods in Segment 3

**Figure 1-7** shows the typical construction limits and proposed construction methods for Segments 3 (deep subtidal zone). In Segment 3, barge mounted earthmoving equipment will be used to dig the trench, install the pipe material, and to bury the new force main. Spoils will be temporarily stockpiled on the bay bottom adjacent to the existing force main, and then placed back into the trench cut. The entire work area will be contained by turbidity screens. Following construction, the new trench cut will be restored back to pre-construction bathymetric elevations. Excess spoils will be used to fill the old trench cut from the existing force main, and supplemented with additional offsite material, as a component of the project mitigation plan discussed in Section 2 below.

The difference in construction methods between Segments 2 and 4, and Segment 3, is that in the shallow subtidal areas smaller shallow-draft barges will be used; whereas in the deeper subtidal areas, larger floating barges with spuds will be used. The smaller shallow-draft barges used in Segments 2 and 4 will rest on the bottom in some areas during low tides, thus causing physical disturbance of the bottom. The larger barges used in Segment 3 will not rest on the bottom; however, some physical disturbance of the bottom will likely occur where spuds are used to secure the barge position.

## 1.5 Project Impacts

The construction limits methods described above have been designed to avoid and minimize impacts to wetlands and submerged habitats to the greatest extent possible. Avoidance and minimization of impacts will be achieved through: 1) routing of the new force main north of the existing force main, which avoids some areas of continuous seagrass by staying within the impact area of the existing force main, and minimizes impacts to mangroves on the west side of the

project; and 2) development of specific construction methods for each segment, which minimize the open-cut trench footprint, as well as secondary impacts caused by temporary turbidity increases. Nonetheless, as proposed, the project will incur impacts to wetlands and submerged habitats.

**Table 1-1** below provides a summary of direct and secondary impacts to wetlands and the submerged habitats of concern in Alignment 1. As noted above, the extent of project impacts has been reduced from the initial permit application submittals, as the project construction limits and methods were subsequently revised to further minimize impacts to wetlands and submerged habitats.

**TABLE 1-1  
SUMMARY OF PROJECT IMPACTS TO WETLANDS AND SUBMERGED HABITATS**

Wetlands and Submerged Habitats	Direct Impact Area (acres)	Secondary Impact Area (acres)	Total Impact Area (acres)
Freshwater Wetlands	0.17	N/A	0.17
Mangroves and Tidal Flats	0.79	N/A	0.79
Seagrasses	1.91	2.41	4.32
Oysters	0.11	N/A	0.11

For seagrasses the impact quantification was based on the 2020 seagrass survey conducted by ESA. The subsequent release of 2020 seagrass maps produced by the Southwest Florida Water Management District have confirmed the general seagrass distribution in the project area as mapped by ESA, and show even less seagrass in the Segment 3 of Alignment 1. For freshwater and intertidal wetland, and oysters, 2020 aerial photography from Manatee County was utilized, supplemented by field surveys.

In Table 1-1, direct impacts represent the land or bottom surface area that will be physically disturbed by excavation of soils and sediments to access the construction areas and install the new force main, followed by the burial of the force main with the same native materials. Secondary impacts represent the surface area of submerged bottom that may be impacted by increased turbidity within the work areas. Secondary impacts areas are outside of the sheet piling that will contain the excavation and force main burial activities, but within turbidity screening that will encompass the entire construction area.

It must be emphasized that all direct and secondary impacts associated with the proposed project using the open-cut trench construction approach will be **temporary impacts only**. There will be no permanent hardening or placement of structures on the land surface or on the bay bottom in the work areas, and there will be no permanent alteration of topographic elevations or bathymetric contours (e.g., permanent dredge and fill areas). All directly impacted areas will be restored back to natural elevations and grades immediately upon installation and burial of the new force main. In addition, as part of the proposed mitigation plan described in Section 2, old trench and dredge cuts will be backfilled to adjacent grade with suitable sediment material and appropriately stabilized to support seagrass recovery in previously impacted areas that have been too deep to support seagrass for over 50 years.

## 2.0 Mitigation Plan

As stated above the mitigation plan described in the following sections addresses the 12 elements of a mitigation plan, as required under 40 CFR Part 230 Compensatory Mitigation for Losses of Aquatic Resources; Final Rule, promulgated by the U.S. Environmental Protection Agency in 2008. In addition to this document, construction plans for the proposed mitigation components are provided as part of the revised *Permit Plans* set, submitted concurrently as part of this response to Requests for Additional Information.

### 2.1 Objectives

The quantitative objectives of this proposed mitigation plan in terms of both acreages and ratios, and the methods to attain these objectives, are summarized in **Table 2-1** below.

**TABLE 2-1**  
**SUMMARY OF MITIGATION PLAN OBJECTIVES AND COMPENSATION METHODS**

Wetlands and Submerged Habitats	Total Impact Area (acres)	Compensation Method(s)	Compensation Area / Ratio (acres)
Freshwater Wetlands	0.17	Restoration	0.17 / 1:1
Mangroves and Tidal Flats	0.79	Restoration/Enhancement	1.18 / 1.5:1
Seagrasses	4.32	Restoration/Establishment	8.64 / 2:1
Oysters	0.11	Restoration/Establishment	0.22 / 2:1

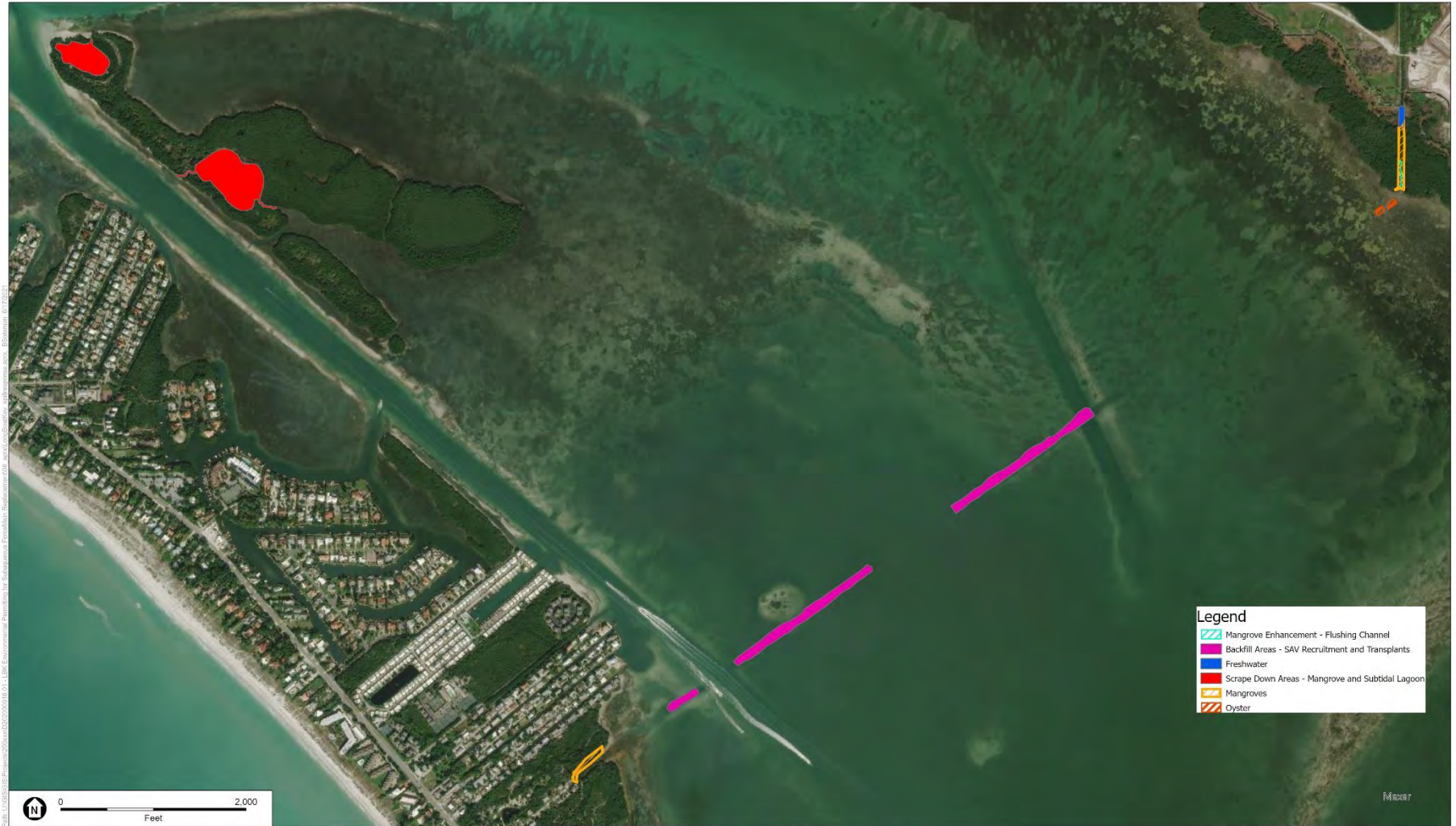
There are four components of this mitigation plan, which correspond to each of the four types of wetlands or submerged habitats to be impacted. Section 2.6 below provides a narrative description of each of the four mitigation components, while the *Mitigation Plan Set* provides plans and general specifications for each component.

### 2.2 Site Selection

All four mitigation components will be conducted onsite within the project limits, and in immediately adjacent or nearby areas. Figure 2-1 below shows the location of each of the four mitigation components.

Onsite mitigation is most appropriate as there are numerous opportunities within the project limits, and in immediately adjacent or nearby areas, where previous dredge and fill impacts can be effectively remediated. There are several old trench and dredge cuts within the project limits that have not supported seagrasses for decades, even during the apex of seagrass expansion in northern Sarasota Bay (circa 2016), as bottom depths are below the photic zone.

In addition to old trench and dredge cuts, Sister Keys - a cluster of mangrove islands owned by the Town of Longboat Key - offer extensive opportunities to restore tidal wetlands in two areas that were filled with dredge spoil material generated during the construction of the ICW. These areas will only be used for mitigation as part of an adaptive management approach if the proposed mitigation has not proven to be successful over the monitoring period.



SOURCE: ESA, 2019.



Town of Longboat Key Subaqueous Force Main  
**Figure 2-1**  
 Longboat Key Mitigation Plan

Given the regional seagrass losses in northern Sarasota Bay, as described in Section 2.4, and the numerous historic dredge and fill impacts in the project vicinity, there are extensive opportunities to accomplish ecologically self-sustaining aquatic resource restoration, establishment, enhancement, and preservation onsite and in immediately adjacent or nearby areas. These mitigation opportunities are the most practical for the affected watershed. All four components of the mitigation plan, as well as success monitoring, can be accomplished most cost-effectively if implemented with the immediate vicinity of the project.

## 2.3 Site Protection Instrument

The primary mitigation site protection instruments will be utility and/or conservation easements recorded by, or dedicated to the Town of Longboat and the State of Florida. The approach for each project segment (see Figure 1-3) is summarized below.

- Segment 1 (western project terminus) – Impacts to mangroves and other intertidal wetlands will be restored on lands currently owned by the Town of Longboat Key. The Town will maintain a utility easement over these areas. The utility easement will allow for any necessary maintenance or repair of the submerged force main, but will otherwise restrict or prohibit any other disturbances or dredge and fill impacts within the easement limits.
- Segments 2, 3, and 4 (submerged lands) – Impacts to seagrasses will be mitigated by backfilling old trench and dredge cuts, and seagrass transplanting, on submerged lands owned by the State of Florida. The Town has applied for a sovereign submerged lands lease and utility easement with the State of Florida. The utility easement will allow for any necessary maintenance or repair of the submerged force mains, but will otherwise restrict prohibit any other disturbances or dredge and fill impacts within the easement limits.
- Segment 5 (eastern project terminus) – Impacts to mangroves and other intertidal wetlands will be restored on lands currently owned by the Long Bar Pointe Mitigation Bank, and will be consistent with the plans approved as part of the mitigation bank permit. The Town will maintain a utility easement over these areas. The utility easement will allow for any necessary maintenance or repair of the submerged force main, but will otherwise restrict or prohibit any other disturbances or dredge and fill impacts within the easement limits.

In addition to mitigation constructed within the project limits, the Town will record a conservation easement over all mitigation areas constructed on Sister Keys (e.g. scrape down of fill areas to create new tidal wetlands) if these areas are subsequently used for mitigation, as part of an adaptive management plan. In summary, all restoration, enhancement, and establishment areas will be protected under protected utility and/or conservation easements in perpetuity.

## 2.4 Baseline Information

Relevant baseline information for the wetlands and submerged habitats affected by the proposed project.

### 2.4.1 Freshwater Wetlands

The only freshwater wetlands to be impacted by the proposed project are highly disturbed wetlands that exist within the existing force main easement, on the eastern terminus (Segment 5) of the project limits. These wetlands are encompassed within the Long Bar Pointe Mitigation Bank, permitted by the FDEP (pending USACE approval). As part of the mitigation bank activities, the property owner cleared extensive Brazilian pepper along the upland fringe of mangroves in this area in 2019 and left these areas non-vegetated, to be restored to native species as part of the mitigation bank master plan. Currently, these wetlands are infested with invasive nuisance species including castor bean and primrose willow, but are expected to be restored pursuant to the specifications defined in the State mitigation bank permit.

### 2.4.2 Mangroves and Tidal Flats

Mangroves and non-vegetated tidal flats and estuarine beaches occur on both the western terminus (Segment 1) and eastern terminus (Segment 5) of the project limits. These are fringe mangrove forests fronting northern Sarasota Bay, and are composed of red (*Rhizophora mangle*), black (*Avicennia germanens*) and white (*Laguncularia racemosa*) mangroves. In Segment 5, the mangrove fringe occurs on lands owned by the Town of Longboat Key (Joan M. Durante Park), and has been impacted by minor historical dredge and fill activities. In Segment 5, the mangrove fringe occurs on lands owned by the Long Bar Pointe Mitigation Bank, and has been impacted by: 1) previous construction of the original force main; 2) temporary road fill associated with the repair of the recent force main leak; and 3) hydrologic stress from the discharge and pooling of raw sewage.

### 2.4.3 Seagrasses

The Southwest Florida Water Management District (SWFWMD) surveys and maps seagrass, oyster, and tidal flat distributions within the coastal waters in its jurisdiction every two years, with data extending back to 1988. Geospatial datasets and maps are produced and provided to the public for resource management purposes. The methodology used to develop these data include the collection of high resolution aerial imagery under ideal conditions for subtidal observations, when water clarity is optimal (e.g. winter months during low tides). The aerial imagery is then groundtruthed in the field and digital polygons of these marine resources are produced through both geospatial machine-learning algorithms and visual digitization. Seagrass is mapped as two categories: 1) sparse; and 2) continuous. **Figure 2-2** shows a time series plot of seagrass coverage in northern Sarasota Bay (e.g., between Siesta Key Drive and Manatee Avenue), as derived from the SWFWMD seagrass mapping program and other historical data sources.



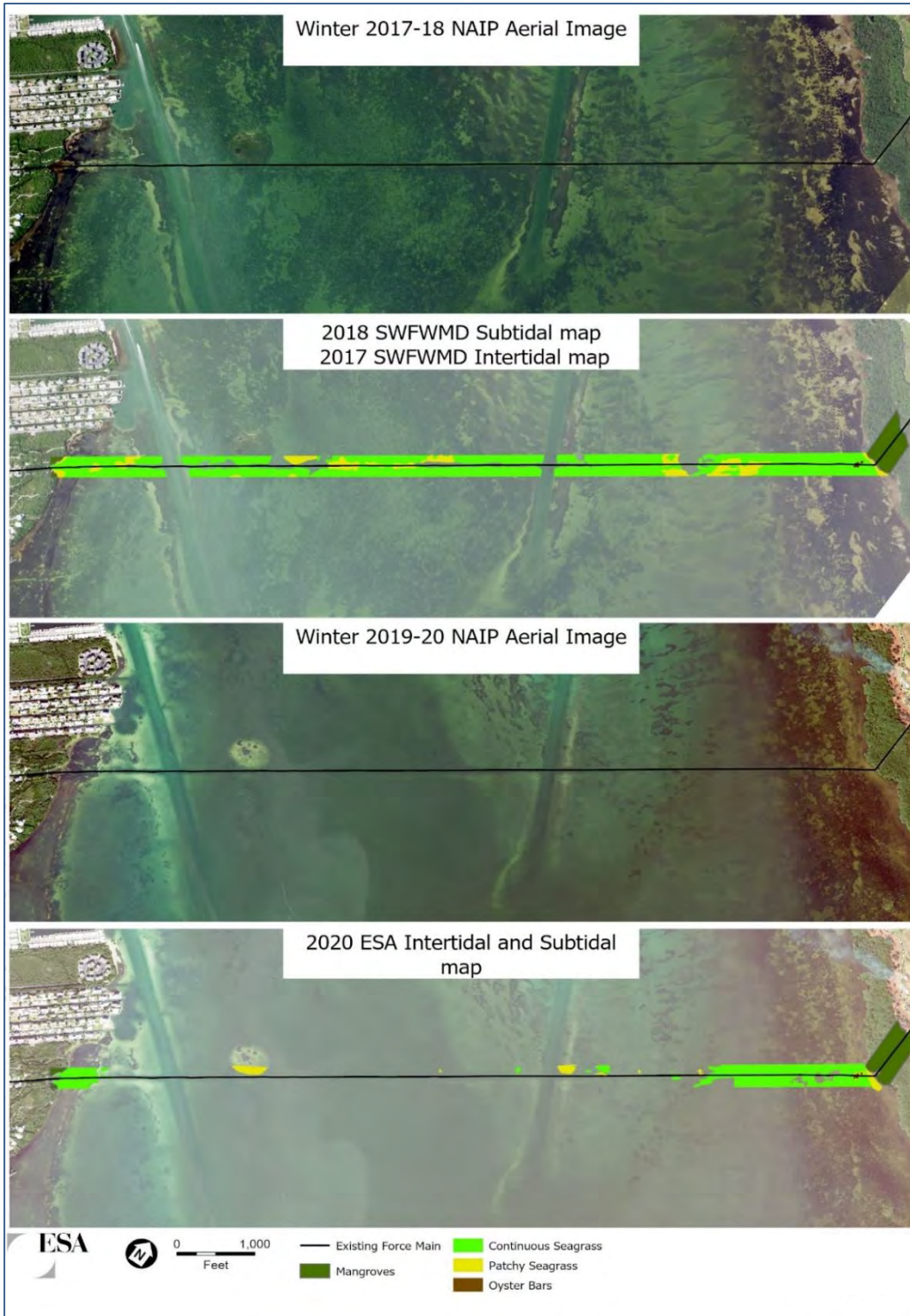


**Figure 2-2**  
Seagrass Acreage Trends in Northern Sarasota Bay

As shown in Figure 2-2, seagrass coverage in northern Sarasota Bay reached its apex in the 2016 mapping period. Beginning in the summer of 2018 there was a protracted red tide event that co-occurred with the sustained chlorophyll-a values seen over the same months. Water quality data collected during this during time period suggest that northern Sarasota Bay was impacted by both a red tide and a more traditional phytoplankton bloom during the period of late 2018 to early 2019. There was also a lesser red tide event in 2016-2017 that didn't appear to have the same effect on chlorophyll-a. Based on SWFWMD seagrass mapping, the 2018-2019 period seems to co-occur with the period during which seagrass meadows have been lost or substantially diminished in the waters north and west of Long Bar Point.

Thus, the combination of algal blooms from both red tide and non-red tide organisms appears to have resulted in a substantial reduction in water clarity, which caused a rapid and massive decline in seagrass coverage in the project vicinity. SWFWMD has recently released their 2020 seagrass maps as provisional, and they indicated even more substantial seagrass losses between 2018 and 2020.

**Figure 2-3** shows seagrass coverage in 2018 (SWFWMD) and 2020 (ESA) within the project limits of Alignment 1, which is represented by a 300-foot wide corridor with the existing force main serving as the centerline. Consistent with observed seagrass trends discussed above, the 2020 seagrass coverage shows a very substantial decline over the 2018 coverage. Of particular note are the deep trenched areas in Segment 3 that did not support seagrass during the 2016 apex of seagrass coverage in this area. Similarly, the entire bottom area of the unnamed is also devoid of seagrass in 2016, and likely has never supported seagrass since it was dredged. As described in the *Permit Support Document*, the cause for the lack of seagrass coverage in these areas is the deeper bottom depths, which fall below the viable photic zone for seagrass recruitment and growth.



**Figure 2-3**  
Seagrass Coverage Within the Project Limits 2017-2020

## 2.4.4 Oysters

Several small (~0.1 acre) oval-shaped oyster reefs occur along the eastern shoreline of northern Sarasota Bay, and appear to be associated with relict karst features and/or minor freshwater spring discharges. In addition to natural oyster reefs, the Sarasota Bay Estuary Program has constructed four oyster reef “restoration” projects along the same shoreline, which appear very similar to the natural reefs. All of the oyster reefs in the project vicinity are low-relief (1-3 feet) clusters of aggregated eastern oyster (*Crassostrea virginica*) shells that occur on the sediment surface. Oyster reefs in the project vicinity have not been significantly impacted by dredge and fill activities nor degraded water quality.

## 2.5 Determination of Credits

As noted above, the extent of project impacts has been reduced from the initial permit application submittals, as the project construction limits and methods were subsequently revised to further minimize impacts to wetlands and submerged habitats. In addition, mitigation options and the proposed mitigation plan have come into better focus. Accordingly, a revised Uniform Mitigation Assessment Methodology (UMAM) analysis has been prepared for project to reflect the reductions in project impacts and quantification and feasibility determination of the four mitigation plan components.

**Table 2-2** below shows the revised UMAM analysis, including risk and time lag factors. This analysis shows that project impacts and mitigation can be feasibly balanced, and that all project impacts should effectively be offset by the proposed mitigation plan activities.

## 2.6 Mitigation Work Plan

Detailed mitigation plans including appropriate plan-view and cross section drawings, and specifications, have been prepared in CADD format and submitted concurrently with this Mitigation Plan document. The narratives provided below describe background information and the mitigation work plan associated with each of the mitigation components.

### 2.6.1 Component 1 – Freshwater Wetlands

The only freshwater wetlands to be impacted by the proposed project occur on the eastern terminus of the project limits. The proposed project will impact approximately 0.17 acres of highly disturbed freshwater wetlands within the existing force main easement. These wetlands are encompassed by the Long Bar Pointe Mitigation Bank, permitted by the FDEP (pending USACE approval).

As part of the mitigation bank activities, the property owner cleared extensive Brazilian pepper along the upland fringe of mangroves in this area in 2019 and left these areas non-vegetated, to be restored with native species as part of the mitigation bank master plan. Currently, these wetlands are infested with invasive nuisance species including castor bean and primrose willow

**TABLE 2-2  
TOWN OF LONGBOAT KEY REDUNDANT SUBAQUEOUS SEWER FORCE MAIN UMAM SUMMARY (REVISED DECEMBER 2021)**

**Impacts**

	Area (Acres)	Landscape		Water		Community Structure		Total Score			Functional Loss
		Pre/Impact	With Impact	Pre/Impact	With Impact	Pre/Impact	With Impact	Pre/Impact	With Impact	Delta	
Freshwater Wetlands	0.17	3	3	3	3	2	0	0.27	0.20	-0.07	-0.01
Mangroves/Tidal Flats	0.79	8	8	7	7	7	0	0.73	0.50	-0.23	-0.18
Seagrasses – Direct	1.91	7	7	7	7	7	0	0.70	0.47	-0.23	-0.45
Seagrasses - Secondary	2.41	7	7	7	7	7	4	0.70	0.60	-0.10	-0.24
Oysters	0.11	8	8	7	7	7	5	0.73	0.67	-0.07	-0.01
<b>Total</b>	<b>5.39</b>									<b>Total</b>	<b>-0.89</b>

**Mitigation**

	Area (Acres)	Landscape		Water		Community Structure		Total Score			Only Used for Preservation		Risk Factors			Functional Gain
		Current	W/Mitigation	Current	W/Mitigation	Current	W/Mitigation	Current	W/Mitigation	Delta	Pres. Adj. Factor	Adj. Mit. Delta	Risk	Time Lag	RFG	
Freshwater wetland restoration via grading and planting with desirable native species	0.17	3	3	3	5	2	8	0.27	0.53	0.27	N/A	N/A	1.50	1.20	0.15	0.03
Mangrove restoration and enhancement via grading, planting, and improved tidal flushing	1.18	8	8	7	8	7	9	0.73	0.83	0.10	N/A	N/A	1.40	1.10	0.06	0.08
Seagrass restoration and establishment via dredge cut backfilling and transplanting plugs from impact areas	8.64	7	7	5	8	3	8	0.50	0.77	0.27	N/A	N/A	2.00	1.50	0.09	0.77
Oyster restoration and establishment via relocation of existing oysters and placement of oyster bags and modules	0.22	7	8	7	8	7	8	0.70	0.80	0.10	N/A	N/A	1.20	1.00	0.08	0.02
<b>Total</b>	<b>10.21</b>											<b>Total</b>	<b>0.89</b>			

**This page intentionally left blank**

Given the current poor condition of wetlands in this area, the Town of Longboat Key proposes to restore 0.17 acres of freshwater wetlands for a mitigation to impact ratio of 1:1. This will be accomplished by direct restoration through grading and planting of the impact areas within the existing force main easement. Native 1-gallon nursery-grown herbaceous wetland plants will be installed on 3-foot centers. The Town will coordinate with the Long Bar Pointe Mitigation Bank to ensure that project mitigation activities are consistent with those approved for this portion of the mitigation bank master plan with respect to the restored topographic contours and wetland plant species mix. Nuisance species management will be conducted for one year to ensure proper plant succession, and ongoing mitigation maintenance activities thereafter will be coordinated with the Long Bar Pointe Mitigation Bank.

### **2.6.2 Component 2 – Mangroves and Tidal Flats**

The proposed project will impact a total of 0.79 acres of mangroves and tidal flats that occur on both the western (Segment 1) and eastern (Segment 5) ends of the project limits. Impacts on the western end of the project occur on lands owned by the Town of Longboat Key, including portions of Joan M. Durante Park. Impacts on the east end of the project occur within the existing force main easement on lands encompassed by the Long Bar Pointe Mitigation Bank, permitted by the FDEP (pending USACE approval).

Given the time lag loss of ecological function as mangrove plantings grow, the Town proposes to restore 1.18 acres of mangroves for a mitigation to impact ratio of 1.5:1. This objective will be attained entirely through onsite restoration and enhancement. To attain this ratio, all mangrove impact areas within the Town's existing utility easement will be restored. Prior to the sewage leak there was approximately 0.2 acres of non-vegetated fill areas along the existing force main alignment, as determined from historical aerial photography. Most of these areas were impacted by the temporary haul road that was constructed to repair the sewage leak. As part of the mitigation plan, these areas will also be restored. Finally, the Town will coordinate with the Long Bar Pointe Mitigation Bank to identify other mangrove restoration areas immediately adjacent to existing utility easement.

Impacted mangroves and non-vegetated tidal flats will be directly restored immediately following installation of the new force main by grading these areas back to pre-construction topographic elevations, and then planting with 1-gallon local nursery-grown mangroves on 3-foot centers. It is anticipated that the majority of the plant material will be black mangroves (*Avicennia germanens*); however, red and white mangroves may also be planted where appropriate based on natural zonation.

The Town will coordinate with the Long Bar Pointe Mitigation Bank to ensure that project mitigation activities are consistent with those approved for this portion of the mitigation bank master plan with respect to the restored topographic contours and wetland plant species mix. Nuisance species management will be conducted for one year to ensure proper plant succession, and ongoing mitigation maintenance activities thereafter will be coordinated with the Long Bar Pointe Mitigation Bank.



### 2.6.3 Component 3 – Seagrasses

As redesigned, the proposed project will directly impact 1.91 acres of seagrasses through excavation, and may result in secondary impacts to seagrasses (through turbidity shading) of up to 2.41 acres (seagrasses contained within turbidity screened areas). The total maximum seagrass impact area is estimated to be 4.32 acres, assuming the destruction of all seagrasses within the secondary impact areas, which is not likely

As discussed in Section 2.4.3 above, as well as the *Permit Support Document* submitted with the permit application, Sarasota Bay has experienced a very substantial seagrass loss over the past 2-3 years due to a severe and extended red tide bloom, and possibly more chronic declines in water clarity. This is particularly true for the northern Sarasota Bay project area. Mitigation for the proposed project has the potential to result in a net environmental benefit to the Sarasota Bay marine ecosystem with respect to seagrass recovery.

Portions of the open cut trench previously excavated for the placement of the existing force main were never properly backfilled, resulting in persistent deep areas with bottom depths that have not supported seagrasses for over 50 years, even when seagrass coverage was at its apex in 2016. In addition, an unnamed dredged channel runs perpendicular to the existing force main along the eastern side of the project. This channel was dredged prior to Clean Water Act requirements, and it too has bottom depths that have not supported seagrasses since it was constructed.

As part of the project mitigation plan, the old trench cut, and a portion of the unmarked dredged channel will be backfilled to adjacent grades with suitable sediment material, and appropriately stabilized, to support seagrass recovery. Identified sources of suitable sediment material to be used for backfilling include:

- Excess excavation material generated from the installation of the new force main; and
- Upland-sourced fill material from FDOT-approved sand mines.

Excess excavation material generated from the installation of the new force main are native fine sands with same grain size distribution and organic matter content as the areas to be backfilled. Upland-sourced fill material will be imported only from FDOT-approved sand mines to ensure compliance with Chapter 62-777, F.A.C. In addition, imported material will be selected from the various available grades to be consistent in grain size composition with native fine sands in the project area. Based on sediment analyses and geotechnical borings, the median sediment particle size (D50) in the project construction corridor ranges from 0.1 to 0.3 millimeters. Upland-sourced fine sands with D50 values on the higher end of this range will ensure that this material is dense enough to be stable when placed in the backfill areas, and not subject to resuspension or erosion.

The Town proposes to backfill 8.73 acres of historical and persistent deep dredge cuts up to the natural adjacent bathymetry, which in most places occurs within the photic zone under current water quality conditions. The fill areas include the old trench cut from the original force main installation, as well as a portion of the unnamed channel. The 8.73 acres of backfill will result in a mitigation to total impact ratio of approximately 2:1. This ratio assumes complete destruction of all seagrass in the secondary impact areas, which is not likely.

Over time, the proper backfilling of these persistent deep areas will fully offset all temporary disturbances to seagrasses associated with project construction, and could result in a net increase in seagrass coverage in the project vicinity as regional seagrass recovery in northern Sarasota Bay progresses. The rate of seagrass recovery in the backfill mitigation areas will be dependent primarily on the finished depth, sediment quality, and water clarity over the long term.

While the depth and sediment quality in the backfilled areas can be controlled in the mitigation construction process, the long-term clarity of the overlying water column will be a function of nutrient inputs to northern Sarasota Bay, as well as other factors such as periodic red tide events. Therefore, unlike the freshwater wetland and mangrove mitigation, natural recruitment and recovery of seagrasses in the project area will not be fully under the control of the Town.

Given the time lag and uncertainties involved in natural seagrass recruitment, the Town will supplement the backfill mitigation component by transplanting 1.5 acres of dense continuous seagrasses from the direct impact areas to adjacent non-vegetated shallow (-2 to -6 depths NAVD88) areas within 200 feet of the construction corridor. This accounts for greater than 50 percent of the mapped continuous seagrasses within the direct impact areas. Transplanting healthy seagrasses from the direct impact areas will both reduce direct impacts and accelerate natural seagrass recruitment and recovery in the project area by providing a local seed source.

Project experience has shown that seagrass transplanting success rates increase when it involves thick continuous seagrass material with dense root mats that can be extracted as consolidated plant/sediment plugs and installed immediately to nearby recipient sites. Therefore, seagrasses will be transplanted by manually excavating 18-inch diameter plugs from the direct impact areas and installing them at natural grade in excavated holes of the same diameter. The Sarasota Bay Estuary Program (SBEP) has indicated that they support this approach to seagrass transplanting for the proposed project, given the current uncertainties in regional water quality status and trends. Furthermore, the SBEP has agreed to assist the Town in selecting appropriate recipient sites, and to monitor their success and expansion over time.

If monitoring indicates that the backfilled deep cut areas are not recruiting seagrass at an acceptable rate, it may be possible to create new shallow subtidal lagoons by scraping down portions of the dredge spoil disposal areas on Sister Keys. Dredge spoil removed from these areas can also potentially be used as a source of suitable fill material to backfill the deep cut areas, as noted above. The Town will consider the restoration of intertidal and subtidal wetlands in these spoil disposal areas, and the beneficial reuse of this spoil material for backfilling other deep dredged cuts, as part of an adaptive management plan if the proposed mitigation does not attain the defined success criteria.

#### **2.6.4 Component 4 – Oysters**

The proposed project will directly impact approximately 0.11 acres of oyster habitat. The impact area is located just offshore of the eastern shoreline, where the new force main construction will transect the northern edge of two small oval-shaped oyster reefs. The oysters present in the project construction area are low-relief accreted shell clusters that reside on the sediment surface. The Town proposes to relocate living oyster clusters from the direct impact areas to the southeast

and southwest sides of the two affected oyster outcrops, prior to the construction of the new force main through these areas.

Relocation of oysters from the direct impact areas prior to construction will significantly reduce oyster impacts, and may avoid oyster impacts entirely. Nonetheless, to provide further reasonable assurance, the Town proposes to restore 0.22 acres of oysters for a mitigation to impact ratio of 2:1. This objective will be attained entirely through onsite restoration and enhancement. The appropriate and proven technique for establishing new oyster reef growth is filling biodegradable mesh bags with cleaned oyster shell, and placing the bags along with hollow concrete oyster modules in locations with suitable salinity and a quiescent wave energy environment. These methods have been successfully used by the Sarasota Bay Estuary Program (SBEP) to create new oyster reefs in northern Sarasota Bay at the same depths with similar bottom conditions as the proposed mitigation for this project.

As proposed, oyster bags and modules will be placed on the southeast and southwest edges of the impacted oyster reefs, outside of the relocated oyster clusters, to extend the perimeter and footprint of the affected reefs such that the objective of 0.22 acres of oyster restoration and enhancement is attained.

## 2.7 Maintenance Plan

The purpose of maintenance activities is to provide continued support of the habitat enhancement, restoration and creation areas such that they attain the desired end points and performance standards. The Town is committed to appropriately maintaining the restored and/or created habitats associated with the four components of this mitigation plan to ensure that the objectives and performance standards are met within the prescribed permit monitoring and maintenance timeframes. Maintenance activities for each of the four mitigation plan components are briefly discussed below, while **Table 2-2** summarizes the maintenance plan components.

### 2.7.1 Component 1 – Freshwater Wetlands

The freshwater wetland restoration areas will be planted with native herbaceous species, consistent with the Long Bar Pointe Mitigation Bank master plan. The planted areas will be monitored to determine plant survival and community succession. Any observed dead plants will be replaced with the same species immediately. If it is determined that the observed successional zonation would better support different species, then the planting plan will be appropriately revised and implemented to ensure that the performance standards are met. In addition, bi-annual maintenance activities will include herbicide spraying as needed to control exotic and nuisance species, to be coordinated with the Long Bar Pointe Mitigation Bank.

### 2.7.2 Component 2 – Mangroves and Tidal Flats

The intertidal wetland restoration areas will be planted with three mangrove species (black, red and white mangroves). The planted areas will be monitored to determine plant survival and community succession. Any observed dead plants will be replaced with the same species immediately. If it is determined that the observed successional zonation would better support

different species, then the planting plan will be appropriately revised and implemented to ensure that the performance standards are met.

### 2.7.3 Component 3 – Seagrasses

Seagrass restoration areas will be backfilled with suitable sediment material to attain design depths within the photic zone. In addition, 1.5 acres of existing seagrass from the direct impact areas will be transplanted into shallower portions of the project construction corridor.

Maintenance activities for the seagrass component will involve monitoring of the backfill areas to ensure that the design depths area being maintained and significant erosion is not occurring. If the backfill material is eroding, then the placement of additional higher-density sediment material may be required. In addition, the seagrass transplant areas will be monitored to determine plant survival and community succession, and that that the design coverage is being attained. Dead individual seagrass transplants will be replaced during the first year of monitoring if it is determined that the overall transplant zone is succeeding (e.g., native sediments and depths are conducive to recruitment).

### 2.7.4 Component 4 – Oysters

The oyster restoration areas involve both relocation of existing oysters and the placement of oyster shell bags and modules along the perimeter of the impacted oyster reefs. Oyster restoration areas will be monitored to ensure that relocated oysters are surviving, and that the oyster bags and modules are recruiting new oysters (e.g., they are in appropriate depth and salinity zones). If either of these criteria are not being met, then the additional oyster bags and/or modules may be placed in other more suitable nearby locations.

**TABLE 2-2  
SUMMARY OF MAINTENANCE PLAN COMPONENTS**

Mitigation Plan Component	Mitigation Area (acres)	Compensation Methods	Maintenance Methods
Freshwater Wetlands	0.17	Plantings	Replacement plantings Exotic controls
Mangroves and Tidal Flats	1.18	Plantings	Replacement plantings Maintenance of tidal flushing channel
Seagrasses	8.64	Backfill deep trench/dredge cuts Transplanting existing seagrass	Maintenance of design depths Replacement transplants
Oysters	0.22	Relocation of existing oysters Placement of shell bags/modules	Additional shell bags/modules

## 2.8 Performance Standards

Performance standards for compensatory mitigation projects are ecologically-based metrics to be used to determine whether the mitigation plan components are attaining the stated objectives. Metrics typically include vegetative, hydrological, and sediment criteria – with specific attainment timeframes - that can be readily measured to document success or failure. **Table 2-3**

shows the proposed performance standards and associated attainment timeframes for each of the mitigation plan components.

**TABLE 2-3  
PROPOSED PERFORMANCE STANDARDS**

Mitigation Plan Component	Mitigation Area (acres)	Performance Standards	Attainment Timeframe
Freshwater Wetlands	0.17	>90% coverage of desirable native species; <10% coverage of exotic/nuisance species	3 years
Mangroves and Tidal Flats	1.18	>90% survival of planted mangroves; >90% coverage mangroves in planted areas Tidal flushing channel functioning properly	4 years
Seagrasses	8.64	100% of backfill areas at design depth; evidence of natural seagrass recruitment >75% survival of seagrass transplants	5 years
Oysters	0.22	>90% survival of relocated oysters; shell bags/modules clearly recruiting new oysters	2 years

## 2.9 Monitoring Requirements

Monitoring of the four mitigation plan components will be critical to attaining the overall plan objectives and the specific performance standards for each. Periodic routine monitoring is required to assess whether the compensatory mitigation project is on track to meet performance standards, or if adaptive management measures are needed. The Town will conduct monitoring of the various mitigation plan components pursuant to the following schedule.

- **Freshwater Wetlands:** time zero (completion of plant installation); 30-days; 90-days, 6-months, 1-year; and annually thereafter.
- **Mangroves and Tidal Flats:** time zero (completion of plant installation); 30-days; 90-days, 6-months, 1-year; and annually thereafter.
- **Seagrass Transplants:** time zero (completion of transplants); 30-days; 90-days, 6-months, 1-year; and annually thereafter.
- **Seagrass Sediment Backfill:** annual bathymetric survey of backfill areas.
- **Oyster Relocation/Enhancement:** time zero (completion of relocation and bag/module placement); 6-months, 1-year; and annually thereafter.

Monitoring will be conducted for a period not to exceed 5 years, to cover the attainment timeframes shown in Table 2-3 above. Monitoring will be discontinued for mitigation components that meet their performance standards at the end of their specified attainment timeframe. However, if a mitigation component is not meeting its performance standard at the end of its attainment timeframe, then monitoring will continue until the performance standard is met. It should also be noted that seagrass extent and density in the project limits, including the

mitigation areas, will be monitoring by SWFWMD every two years as part of their routine seagrass and subtidal habitat mapping program.

The Town will also submit comprehensive annual monitoring reports to the Florida Department of Environmental Protection (FDEP) USACE, and NMFS. A total of five (5) annual monitoring reports will be submitted unless monitoring is extended due to a failure to meet a specified performance standard. The annual monitoring reports shall include all required content, and be provided in the format, specified in *Regulatory Guidance Letter 08-03: Minimum Monitoring Requirements for Compensatory Mitigation Projects Involving the Restoration, Establishment, and/or Enhancement of Aquatic Resources* (USACE, 2008).

## 2.10 Long-Term Management Plan

Long-term management of the four mitigation plan components will be addressed primarily through their respective landscape locations.

### 2.10.1 Component 1 – Freshwater Wetlands

One freshwater wetland mitigation area is located at the east end of the project limits will become part of the Long Bar Pointe Mitigation Bank. Although a utility easement will remain over both the existing and new force main, habitats and vegetation communities within the easement will be protected and managed consistent with the State mitigation bank permit

### 2.10.2 Component 2 – Mangroves and Intertidal Habitats

Mangrove and intertidal habitat mitigation areas are located on both the west and east ends of the project limits. On the west side, this mitigation will be conducted within Joan Durante Park, a natural and recreational area owned by the Town of Longboat Key. Protection and management of these areas will be conducted as part of the park management plan. On the east side, the mangrove mitigation will become part of the Long Bar Pointe Mitigation Bank. Although a utility easement will remain over both the existing and new force main, habitats and vegetation communities within the easement will be managed as part of the mitigation bank permit. Additional mangrove and intertidal wetland mitigation that may be constructed on Sister Keys as part of an adaptive management plan will be managed as natural areas by the Town of Longboat Key, the owner of the property.

### 2.10.3 Component 3 – Seagrasses

Seagrass mitigation areas located within the subtidal portions of the force main construction corridor will remain under the ownership of the State of Florida as sovereign submerged lands. Although a utility easement will remain over both the existing and new force main, seagrasses and other subtidal habitats will be protected and subject to the resource and water quality management conducted by multiple agencies including the Florida Department of Environmental Protection, the Florida Fish and Wildlife Conservation Commission, and the Sarasota Bay Estuary Program. In addition, SWFWMD will continue to monitor and map seagrasses and other subtidal habitats in the project vicinity. Additional seagrass and subtidal habitat mitigation that



may be constructed on Sister Keys will be managed as natural areas by the Town of Longboat Key, the owner of the property.

#### **2.10.4 Component 4 – Oysters**

The oyster mitigation located within the subtidal portions of the force main construction corridor will remain under the ownership of the State of Florida as sovereign submerged lands. Although a utility easement will remain over both the existing and new force main, seagrasses and other subtidal habitats will be protected and subject to resource management conducted by multiple agencies including the Florida Department of Environmental Protection, the Florida Fish and Wildlife Conservation Commission, and the Sarasota Bay Estuary Program. In addition, SWFWMD will continue to monitor and map seagrasses and oyster reefs in the project vicinity.

### **2.11 Adaptive Management Plan**

Adaptive management refers to a management strategy that addresses unforeseen changes in site conditions or other components of a compensatory mitigation project, including the party or parties responsible for implementing adaptive management measures.

Clearly, the most unpredictable aspect of the proposed mitigation plan is the natural recovery of seagrasses within the project vicinity. The primary factor involved in seagrass recovery within the project vicinity is water clarity, which in turn is a function of nutrient inputs as well as periodic red tide events. The Town has little or no control in maintaining or improving regional water clarity. Therefore, the primary goal of the seagrass mitigation component is to restore bathymetric and benthic conditions such that they will support natural seagrass recovery when water quality conditions are suitable. To help offset this risk, the Town has proposed to transplant 1.5 acres of the dense continuous seagrass from direct impacts areas to shallower areas (<6 feet deep) within the project limits to increase the probability of transplant success.

If the seagrass mitigation component proves to be unsuccessful, and performance standards are not being met by year 5, the Town will coordinate with state and federal agencies to develop an appropriate adaptive management plan. Sister Keys owned by the Town of Longboat Key offers numerous marine and estuarine habitat restoration opportunities. The excavation of spoil disposal areas on Sister Keys to create shallow tidal lagoons with subtidal habitat suitable for seagrass recruitment is proposed as an adaptive management strategy to offset the unlikely failure of the seagrass mitigation plan described herein. However, as noted previously, the Town would prefer to pursue such work on Sister Keys as part of a cooperatively-funded habitat restoration project.

Given the relative certainty of attaining performance standards, adaptive management strategies are not proposed or needed for the freshwater wetland, mangrove/tidal flat, and oyster components of the mitigation plan.

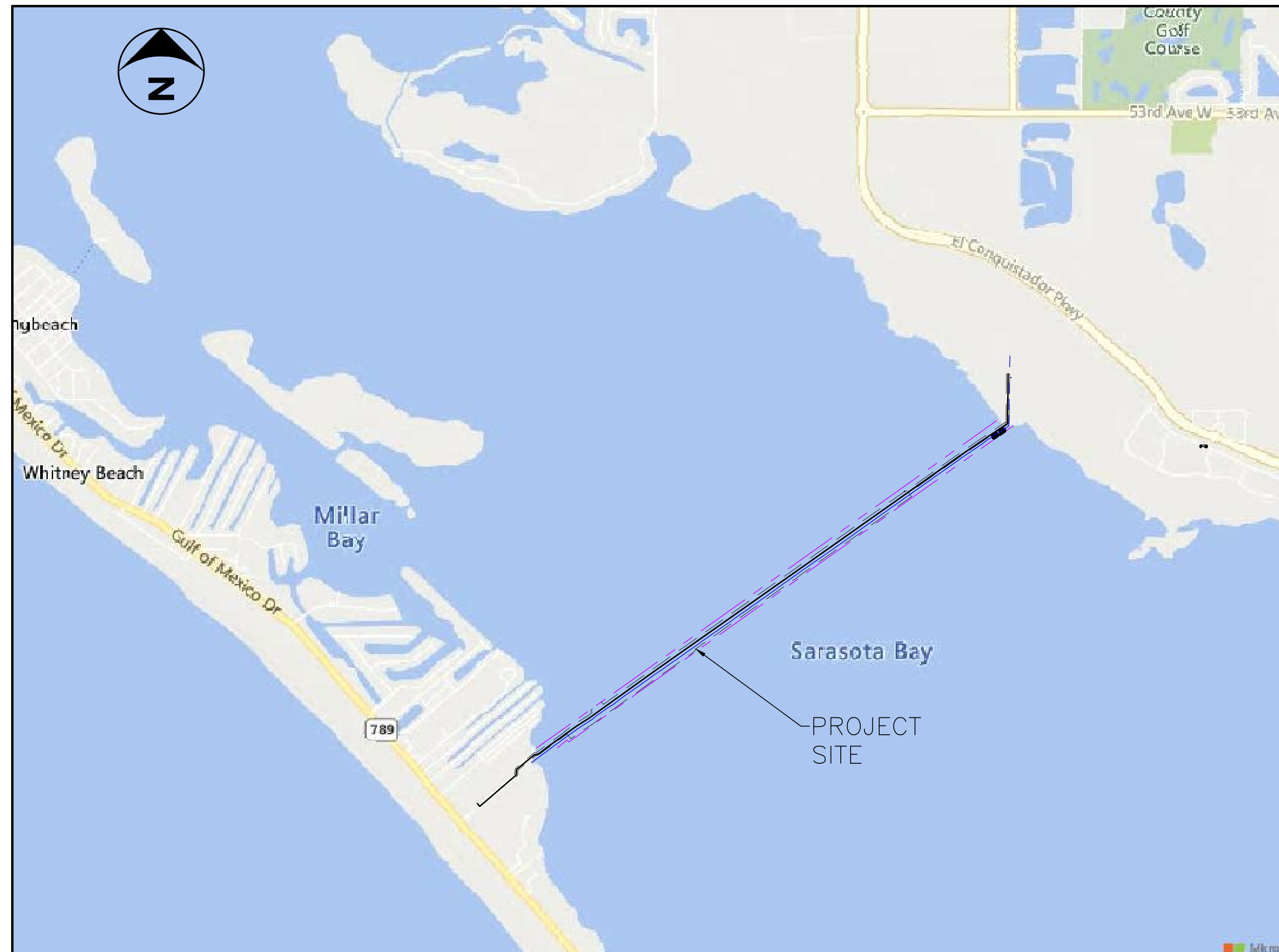
### **2.12 Financial Assurances**

The Town of Longboat Key, an incorporated local government in the State of Florida, will be responsible for the full implementation of this mitigation plan, including construction, monitoring, and maintenance as part of the construction of a new redundant force main along the

preferred alignment. As described in Section 1 above, the proposed redundant sewer force main project is a critical infrastructure need for the Town of Longboat Key. The project is a component of the Town's Capital Improvement Program (CIP), and will be fully funded to include all mitigation commitments described herein.

# TOWN OF LONGBOAT KEY SUBAQUEOUS FORCEMAIN PROJECT MITIGATION PLAN SET NOT FOR CONSTRUCTION

DECEMBER 9, 2021  
TOWN OF LONGBOAT KEY, FL



Sheet List Table	
Sheet Number	Sheet Title
G-1	COVER SHEET
G-2	OVERVIEW PLAN
C-1	FILL AREAS FOR SAV MITIGATION
C-2	FILL AREAS FOR SAV MITIGATION
C-3	FILL AREAS FOR SAV MITIGATION
C-4	FILL AREAS FOR SAV MITIGATION
C-5	FILL AREAS FOR SAV MITIGATION
C-6	FILL AREAS FOR SAV MITIGATION
C-7	FILL AREAS FOR SAV MITIGATION
C-8	FILL AREAS FOR SAV MITIGATION
C-9	FILL AREAS FOR SAV MITIGATION
C-10	EAST SHORE WETLAND & OYSTER MITIGATION
C-11	EAST SHORE WETLAND & OYSTER MITIGATION
C-12	TYPICAL SECTIONS - SAV FILL AREAS
C-13	TYPICAL SECTIONS EAST FILL AREA
C-14	MITIGATION DETAILS
C-15	BMP - DETAILS

**ESA**  
4200 WEST CYPRESS ST.,  
STE. 450  
TAMPA, FL 33607  
OFFICE - 813.207.7200  
WWW.ESASSOC.COM

STAMP

CONSULTANT

PROJECT NAME  
**LONGBOAT KEY  
MITIGATION PLAN**  
 501 BAY ISLES ROAD  
 LONGBOAT KEY, FL 34228

REVISIONS

#	DATE	DESCRIPTION

DESIGNED	BDF & ED
DRAWN	BDF
CHECKED	DR
IN CHARGE	BDF FL PE 70856

PROJECT NUMBER D202000016.01

ISSUE DATE 12/09/2021

SCALE IS AS SHOWN WHEN  
PLOTTED TO FULL SIZE (22"x34")  
1" = 1'

PHASE  
60% DESIGN

SHEET TITLE

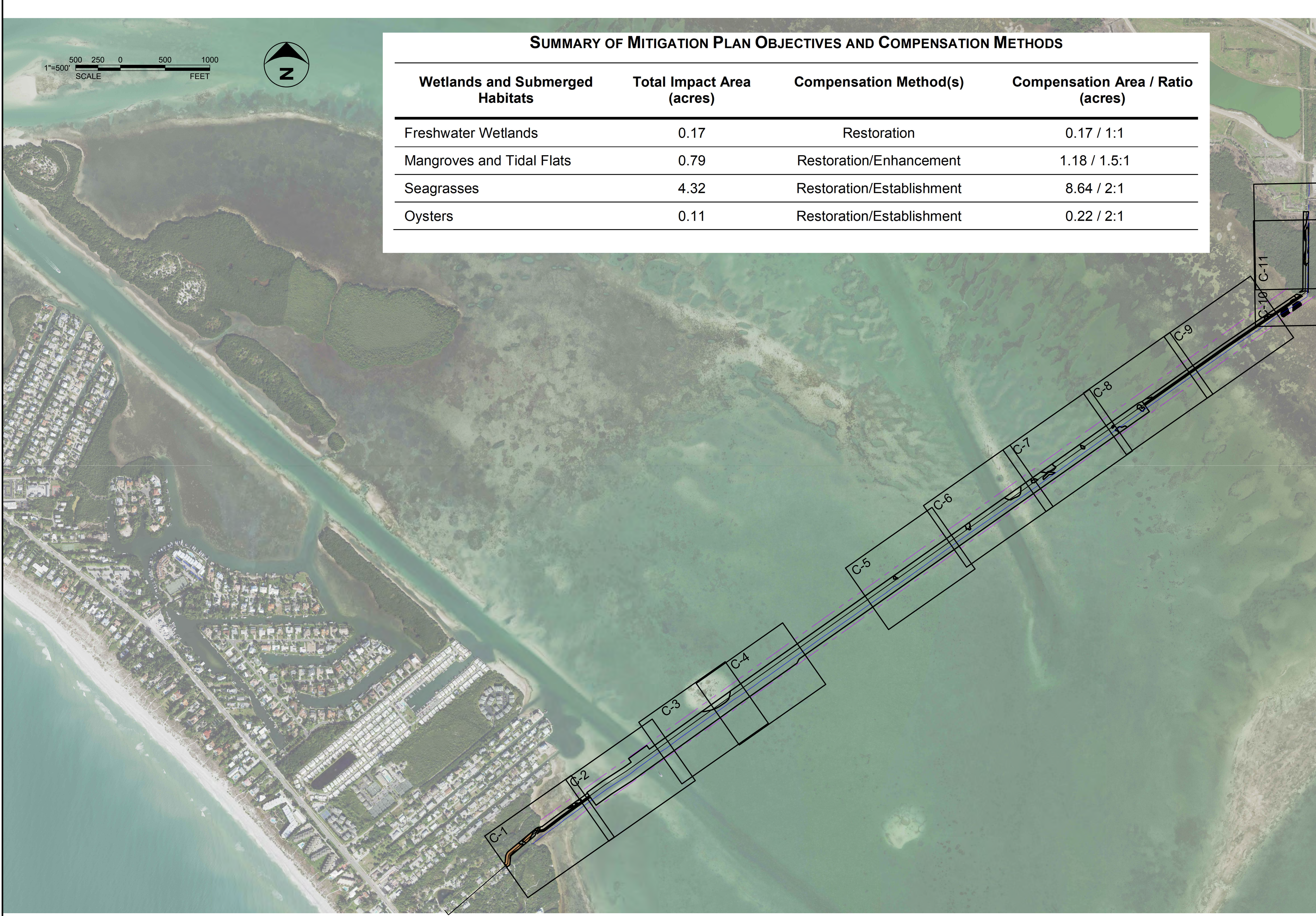
COVER SHEET

SHEET NUMBER

**G-1**

SHEET 1 OF 17





**SUMMARY OF MITIGATION PLAN OBJECTIVES AND COMPENSATION METHODS**

Wetlands and Submerged Habitats	Total Impact Area (acres)	Compensation Method(s)	Compensation Area / Ratio (acres)
Freshwater Wetlands	0.17	Restoration	0.17 / 1:1
Mangroves and Tidal Flats	0.79	Restoration/Enhancement	1.18 / 1.5:1
Seagrasses	4.32	Restoration/Establishment	8.64 / 2:1
Oysters	0.11	Restoration/Establishment	0.22 / 2:1

**ESA**  
 4200 WEST CYPRESS ST.,  
 STE. 450  
 TAMPA, FL 33607  
 OFFICE - 813.207.7200  
 WWW.ESASSOC.COM

STAMP

CONSULTANT

**LONGBOAT KEY  
 MITIGATION PLAN**  
 501 BAY ISLES ROAD  
 LONGBOAT KEY, FL 34228

REVISIONS  
 # DATE DESCRIPTION

DESIGNED BDF & ED  
 DRAWN BDF  
 CHECKED DR  
 IN CHARGE BDF  
 FL PE 70856

PROJECT NUMBER D202000016.01

ISSUE DATE 12/09/2021

SCALE IS AS SHOWN WHEN  
 PLOTTED TO FULL SIZE (22"x34")  
 1" = 100'

PHASE  
 60% DESIGN

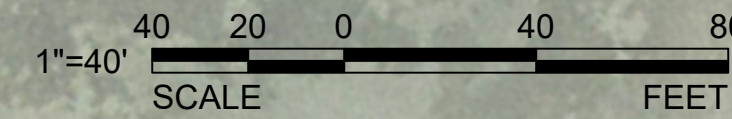
SHEET TITLE

MITIGATION PLAN -  
 OVERVIEW

SHEET NUMBER  
**G-2**

SHEET 2 OF 17





4200 WEST CYPRESS ST.,  
STE. 450  
TAMPA, FL 33607  
OFFICE - 813.207.7200  
WWW.ESASSOC.COM

STAMP

CONSULTANT

**LONGBOAT KEY  
MITIGATION PLAN**

501 BAY ISLES ROAD  
LONGBOAT KEY, FL 34228

PROJECT NAME

REVISIONS  
# DATE DESCRIPTION

DESIGNED	BDF & ED
DRAWN	BDF
CHECKED	DR
IN CHARGE	BDF FL PE 70856

PROJECT NUMBER D2020000016.01

ISSUE DATE 12/09/2021

SCALE IS AS SHOWN WHEN  
PLOTTED TO FULL SIZE (22"x34")  
1" = 40'

PHASE  
60% DESIGN

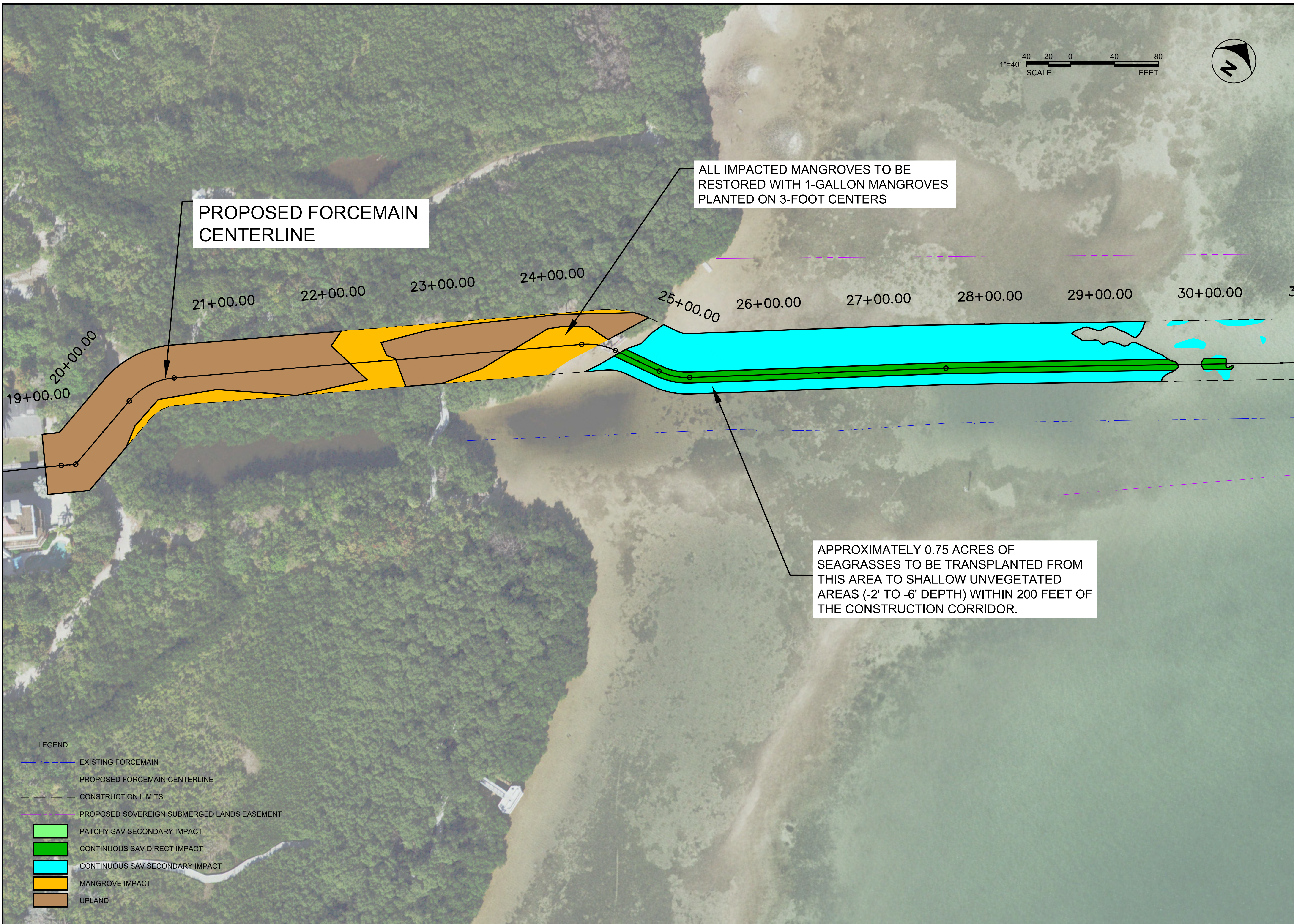
SHEET TITLE

WEST FILL AREA -  
SAV MITIGATION

SHEET NUMBER

**C-1**

SHEET 3 OF 17



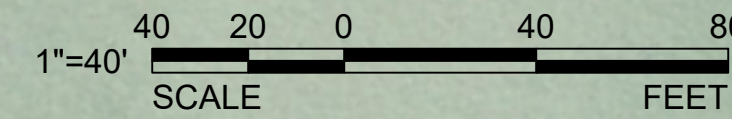
**PROPOSED FORCEMAIN  
CENTERLINE**

ALL IMPACTED MANGROVES TO BE  
RESTORED WITH 1-GALLON MANGROVES  
PLANTED ON 3-FOOT CENTERS

APPROXIMATELY 0.75 ACRES OF  
SEAGRASSES TO BE TRANSPLANTED FROM  
THIS AREA TO SHALLOW UNVEGETATED  
AREAS (-2' TO -6' DEPTH) WITHIN 200 FEET OF  
THE CONSTRUCTION CORRIDOR.

- LEGEND:
- EXISTING FORCEMAIN
  - PROPOSED FORCEMAIN CENTERLINE
  - CONSTRUCTION LIMITS
  - PROPOSED SOVEREIGN SUBMERGED LANDS EASEMENT
  - PATCHY SAV SECONDARY IMPACT
  - CONTINUOUS SAV DIRECT IMPACT
  - CONTINUOUS SAV SECONDARY IMPACT
  - MANGROVE IMPACT
  - UPLAND





4200 WEST CYPRESS ST.,  
STE. 450  
TAMPA, FL 33607  
OFFICE - 813.207.7200  
WWW.ESASSOC.COM

STAMP

CONSULTANT

PROJECT NAME

**LONGBOAT KEY  
MITIGATION PLAN**

501 BAY ISLES ROAD  
LONGBOAT KEY, FL 34228

REVISIONS

#	DATE	DESCRIPTION

DESIGNED	BDF & ED
DRAWN	BDF
CHECKED	DR
IN CHARGE	BDF FL PE 70856

DRAWN	BDF
CHECKED	DR
IN CHARGE	BDF FL PE 70856

IN CHARGE	BDF FL PE 70856
-----------	--------------------

PROJECT NUMBER	D2020000016.01
----------------	----------------

ISSUE DATE	12/09/2021
------------	------------

SCALE IS AS SHOWN WHEN  
PLOTTED TO FULL SIZE (22"x34")  
1" = 40'

PHASE	60% DESIGN
-------	------------

SHEET TITLE

**WEST FILL AREA -  
SAV MITIGATION**

SHEET NUMBER

**C-2**

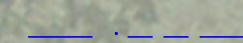
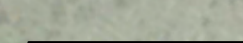
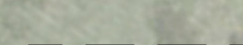

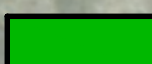
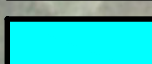

SHEET 4 OF 17

**PROPOSED FORCEMAIN  
CENTERLINE**

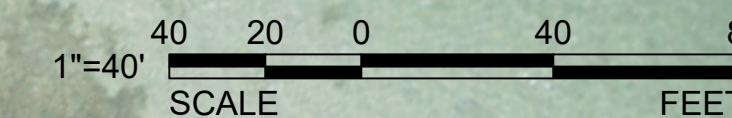
APPROXIMATELY 0.75 ACRES OF  
SEAGRASSES TO BE TRANSPLANTED FROM  
THIS AREA TO SHALLOW UNVEGETATED  
AREAS (-2' TO -6' DEPTH) WITHIN 200 FEET OF  
THE CONSTRUCTION CORRIDOR.

FILL AREA = 0.7 ACRES

LEGEND:

-  EXISTING FORCEMAIN
-  PROPOSED FORCEMAIN CENTERLINE
-  CONSTRUCTION LIMITS
-  PROPOSED SOVEREIGN SUBMERGED LANDS EASEMENT
-  CONTINUOUS SAV DIRECT IMPACT
-  CONTINUOUS SAV SECONDARY IMPACT
-  FILL AREA FOR SAV RECRUITMENT





**PROPOSED FORCEMAIN  
CENTERLINE**

41+00.00    42+00.00    43+00.00    44+00.00    45+00.00    46+00.00    47+00.00    48+00.00    49+00.00    50+00.00    51+00.00    52+00.00

MIDDLE FILL AREA = 3.90 ACRES

- LEGEND:
- EXISTING FORCEMAIN
  - PROPOSED FORCEMAIN CENTERLINE
  - CONSTRUCTION LIMITS
  - PROPOSED SOVEREIGN SUBMERGED LANDS EASEMENT
  - FILL AREA FOR SAV RECRUITMENT

STAMP

CONSULTANT

**LONGBOAT KEY  
MITIGATION PLAN**

501 BAY ISLES ROAD  
LONGBOAT KEY, FL 34228

PROJECT NAME

REVISIONS  
#    DATE    DESCRIPTION

DESIGNED	BDF & ED
DRAWN	BDF
CHECKED	DR
IN CHARGE	BDF FL PE 70856

PROJECT NUMBER D2020000016.01

ISSUE DATE 12/09/2021

SCALE IS AS SHOWN WHEN  
PLOTTED TO FULL SIZE (22"x34")  
1" = 40'

PHASE  
**60% DESIGN**

SHEET TITLE

**MIDDLE FILL AREA -  
SAV MITIGATION**

SHEET NUMBER

**C-3**

SHEET 5 OF 17



STAMP

CONSULTANT

**LONGBOAT KEY  
MITIGATION PLAN**

501 BAY ISLES ROAD  
LONGBOAT KEY, FL 34228

PROJECT NAME

REVISIONS  
# DATE DESCRIPTION

DESIGNED	BDF & ED
DRAWN	BDF
CHECKED	DR
IN CHARGE	BDF FL PE 70856

PROJECT NUMBER D2020000016.01

ISSUE DATE 12/09/2021

SCALE IS AS SHOWN WHEN  
PLOTTED TO FULL SIZE (22"x34")  
1" = 40'

PHASE  
**60% DESIGN**

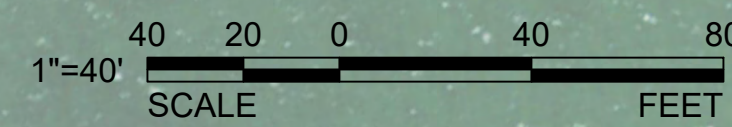
SHEET TITLE

**MIDDLE FILL AREA -  
SAV MITIGATION**

SHEET NUMBER

**C-4**

SHEET 6 OF 17



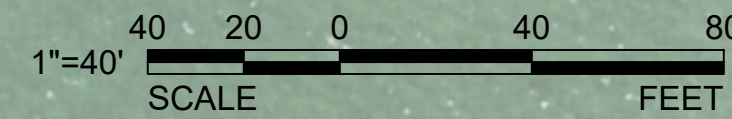
**PROPOSED FORCEMAIN  
CENTERLINE**

49+00.00 50+00.00 51+00.00 52+00.00 53+00.00 54+00.00 55+00.00 56+00.00 57+00.00 58+00.00 59+00.00 60+00.00

- LEGEND:
- EXISTING FORCEMAIN
  - PROPOSED FORCEMAIN CENTERLINE
  - CONSTRUCTION LIMITS
  - PROPOSED SOVEREIGN SUBMERGED LANDS EASEMENT
  - FILL AREA FOR SAV RECRUITMENT







**ESA**  
 4200 WEST CYPRESS ST.,  
 STE. 450  
 TAMPA, FL 33607  
 OFFICE - 813.207.7200  
 WWW.ESASSOC.COM

STAMP

CONSULTANT

**LONGBOAT KEY  
 MITIGATION PLAN**  
 501 BAY ISLES ROAD  
 LONGBOAT KEY, FL 34228

PROJECT NAME

REVISIONS

#	DATE	DESCRIPTION

DESIGNED	BDF & ED
DRAWN	BDF
CHECKED	DR
IN CHARGE	BDF FL PE 70856

PROJECT NUMBER D2020000016.01

ISSUE DATE 12/09/2021

SCALE IS AS SHOWN WHEN  
 PLOTTED TO FULL SIZE (22"x34")  
 1" = 40'

PHASE  
 60% DESIGN

SHEET TITLE

**EAST FILL AREA -  
 SAV MITIGATION**

SHEET NUMBER

**C-5**

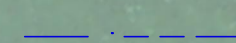
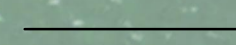
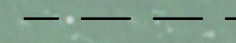
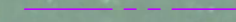
SHEET 7 OF 17

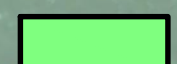
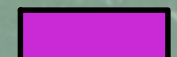
**PROPOSED FORCEMAIN  
 CENTERLINE**

70+00.00 71+00.00 72+00.00 73+00.00 74+00.00 75+00.00 76+00.00 77+00.00 78+00.00 79+00.00 80+00.00 81+00.00

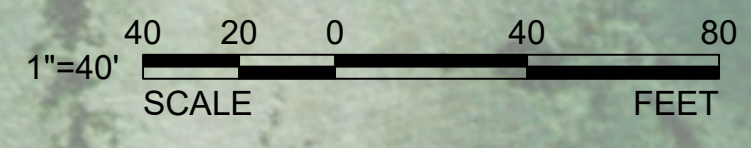
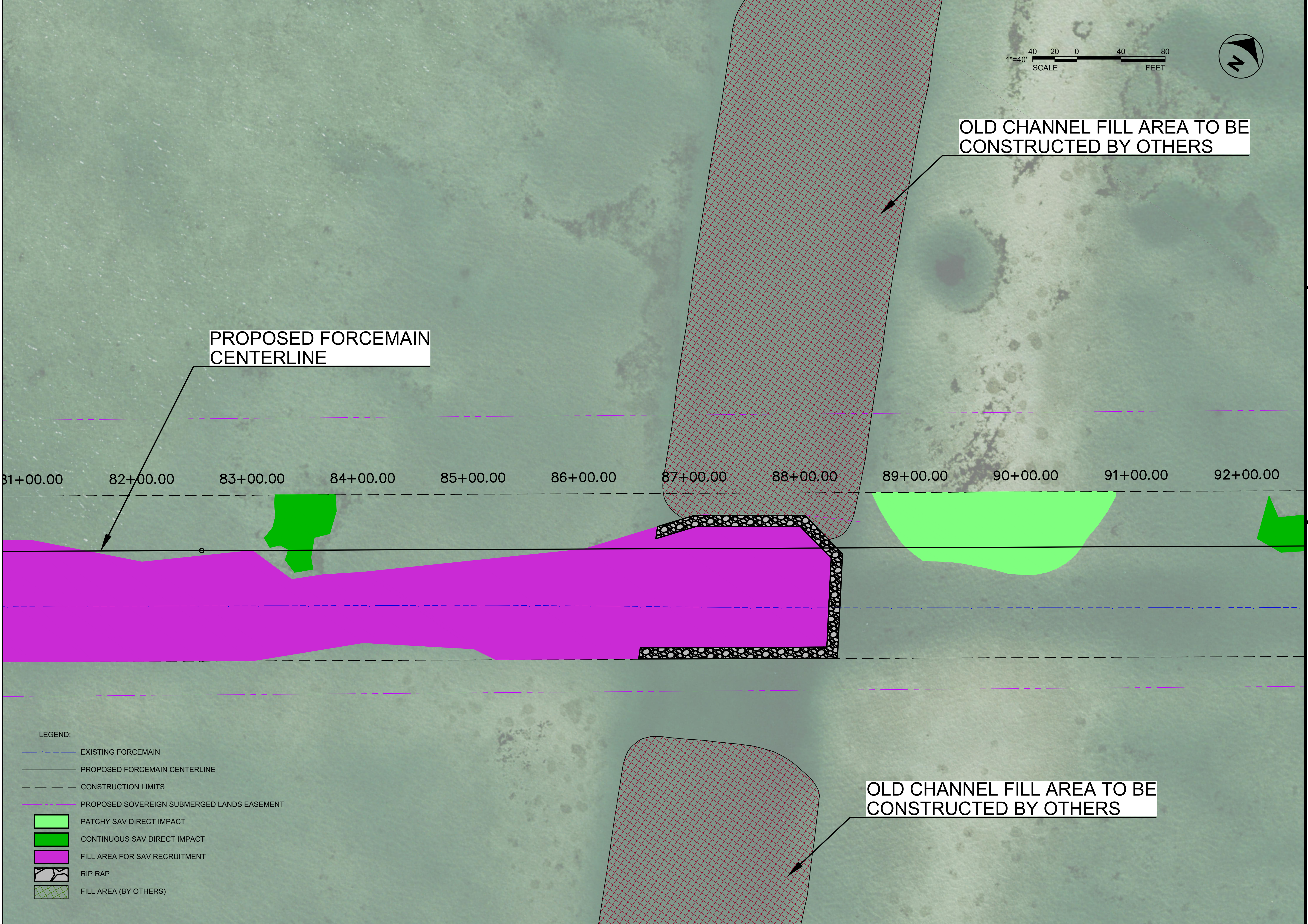
EAST FILL AREA = 4.00 ACRES

LEGEND:

-  EXISTING FORCEMAIN
-  PROPOSED FORCEMAIN CENTERLINE
-  CONSTRUCTION LIMITS
-  PROPOSED SOVEREIGN SUBMERGED LANDS EASEMENT

-  PATCHY SAV DIRECT IMPACT
-  FILL AREA FOR SAV RECRUITMENT





OLD CHANNEL FILL AREA TO BE CONSTRUCTED BY OTHERS

PROPOSED FORCEMAIN CENTERLINE

OLD CHANNEL FILL AREA TO BE CONSTRUCTED BY OTHERS

- LEGEND:
- EXISTING FORCEMAIN
  - PROPOSED FORCEMAIN CENTERLINE
  - - - CONSTRUCTION LIMITS
  - - - PROPOSED SOVEREIGN SUBMERGED LANDS EASEMENT
  - █ PATCHY SAV DIRECT IMPACT
  - █ CONTINUOUS SAV DIRECT IMPACT
  - █ FILL AREA FOR SAV RECRUITMENT
  - █ RIP RAP
  - █ FILL AREA (BY OTHERS)

**ESA**  
 4200 WEST CYPRESS ST.,  
 STE. 450  
 TAMPA, FL 33607  
 OFFICE - 813.207.7200  
 WWW.ESASSOC.COM

STAMP

CONSULTANT

PROJECT NAME  
**LONGBOAT KEY  
 MITIGATION PLAN**  
 501 BAY ISLES ROAD  
 LONGBOAT KEY, FL 34228

REVISIONS

#	DATE	DESCRIPTION

DESIGNED	BDF & ED
DRAWN	BDF
CHECKED	DR
IN CHARGE	BDF FL PE 70856

PROJECT NUMBER D202000016.01

ISSUE DATE 12/09/2021

SCALE IS AS SHOWN WHEN  
 PLOTTED TO FULL SIZE (22"x34")  
 1" = 40'

PHASE  
 60% DESIGN

SHEET TITLE

EAST FILL AREA -  
 SAV MITIGATION

SHEET NUMBER

**C-6**

SHEET 8 OF 17



1"=40'  
SCALE FEET



4200 WEST CYPRESS ST.,  
STE. 450  
TAMPA, FL 33607  
OFFICE - 813.207.7200  
WWW.ESASSOC.COM

STAMP

CONSULTANT

**LONGBOAT KEY  
MITIGATION PLAN**

501 BAY ISLES ROAD  
LONGBOAT KEY, FL 34228

PROJECT NAME

REVISIONS

#	DATE	DESCRIPTION

DESIGNED	BDF & ED
DRAWN	BDF
CHECKED	DR
IN CHARGE	BDF FL PE 70856

PROJECT NUMBER D202000016.01

ISSUE DATE 12/09/2021

SCALE IS AS SHOWN WHEN  
PLOTTED TO FULL SIZE (22"x34")  
1" = 40'

PHASE  
60% DESIGN

SHEET TITLE

**EAST FILL AREA -  
SAV MITIGATION**

SHEET NUMBER

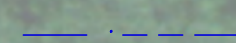
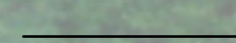
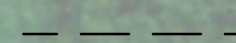
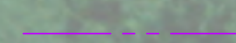
**C-7**

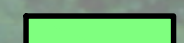
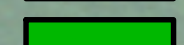
SHEET 9 OF 17

**PROPOSED FORCEMAIN  
CENTERLINE**

94+00.00 95+00.00 96+00.00 97+00.00 98+00.00 99+00.00 100+00.00 101+00.00 102+00.00 103+00.00 104+00.00 105+00.00

LEGEND:

-  EXISTING FORCEMAIN
-  PROPOSED FORCEMAIN CENTERLINE
-  CONSTRUCTION LIMITS
-  PROPOSED SOVEREIGN SUBMERGED LANDS EASEMENT

-  PATCHY SAV DIRECT IMPACT
-  CONTINUOUS SAV DIRECT IMPACT



1"=40'  
SCALE FEET



**ESA**

4200 WEST CYPRESS ST.,  
STE. 450  
TAMPA, FL 33607  
OFFICE - 813.207.7200  
WWW.ESASSOC.COM

STAMP

CONSULTANT

**LONGBOAT KEY  
MITIGATION PLAN**

501 BAY ISLES ROAD  
LONGBOAT KEY, FL 34228

PROJECT NAME

REVISIONS

#	DATE	DESCRIPTION

DESIGNED	BDF & ED
DRAWN	BDF
CHECKED	DR
IN CHARGE	BDF
	FL PE 70856

PROJECT NUMBER	D2020000016.01
----------------	----------------

ISSUE DATE	12/09/2021
------------	------------

SCALE IS AS SHOWN WHEN PLOTTED TO FULL SIZE (22"x34")
---

SCALE	1" = 40'
-------	----------

PHASE	60% DESIGN
-------	------------

PHASE	60% DESIGN
-------	------------

PHASE	60% DESIGN
-------	------------

PHASE	60% DESIGN
-------	------------

PHASE	60% DESIGN
-------	------------

PHASE	60% DESIGN
-------	------------

PHASE	60% DESIGN
-------	------------

PHASE	60% DESIGN
-------	------------

PHASE	60% DESIGN
-------	------------

PHASE	60% DESIGN
-------	------------

PHASE	60% DESIGN
-------	------------

PHASE	60% DESIGN
-------	------------

PHASE	60% DESIGN
-------	------------

PHASE	60% DESIGN
-------	------------

PHASE	60% DESIGN
-------	------------

PHASE	60% DESIGN
-------	------------

PHASE	60% DESIGN
-------	------------

PHASE	60% DESIGN
-------	------------

PHASE	60% DESIGN
-------	------------

PHASE	60% DESIGN
-------	------------

PHASE	60% DESIGN
-------	------------

PHASE	60% DESIGN
-------	------------

PHASE	60% DESIGN
-------	------------

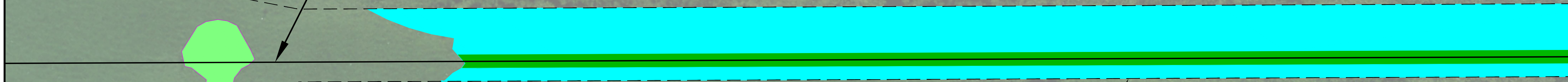
PHASE	60% DESIGN
-------	------------

00 106+00.00 107+00.00 108+00.00 109+00.00 110+00.00 111+00.00 112+00.00 113+00.00 114+00.00 115+00.00 116+00.00 117+

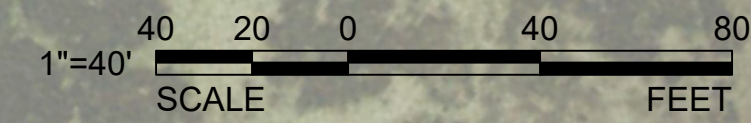
**PROPOSED FORCEMAIN CENTERLINE**

APPROXIMATELY 0.75 ACRES OF SEAGRASSES TO BE TRANSPLANTED FROM THIS AREA TO SHALLOW UNVEGETATED AREAS (-2' TO -6' DEPTH) WITHIN 200 FEET OF THE CONSTRUCTION CORRIDOR.

- LEGEND:
- EXISTING FORCEMAIN
  - PROPOSED FORCEMAIN CENTERLINE
  - CONSTRUCTION LIMITS
  - PROPOSED SOVEREIGN SUBMERGED LANDS EASEMENT
  - PATCHY SAV DIRECT IMPACT
  - CONTINUOUS SAV DIRECT IMPACT
  - CONTINUOUS SAV SECONDARY IMPACT







4200 WEST CYPRESS ST.,  
STE. 450  
TAMPA, FL 33607  
OFFICE - 813.207.7200  
WWW.ESASSOC.COM

STAMP

CONSULTANT

**LONGBOAT KEY  
MITIGATION PLAN**

501 BAY ISLES ROAD  
LONGBOAT KEY, FL 34228

PROJECT NAME

REVISIONS  
# DATE DESCRIPTION

#	DATE	DESCRIPTION

DESIGNED	BDF & ED
DRAWN	BDF
CHECKED	DR
IN CHARGE	BDF FL PE 70856

PROJECT NUMBER D202000016.01

ISSUE DATE 12/09/2021

SCALE IS AS SHOWN WHEN  
PLOTTED TO FULL SIZE (22"x34")  
1" = 40'

PHASE  
60% DESIGN

SHEET TITLE

**EAST FILL AREA -  
SAV MITIGATION**

SHEET NUMBER

**C-9**

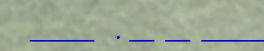
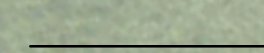
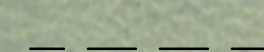
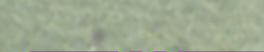
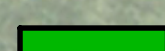




SHEET 11 OF 17

**PROPOSED FORCEMAIN  
CENTERLINE**

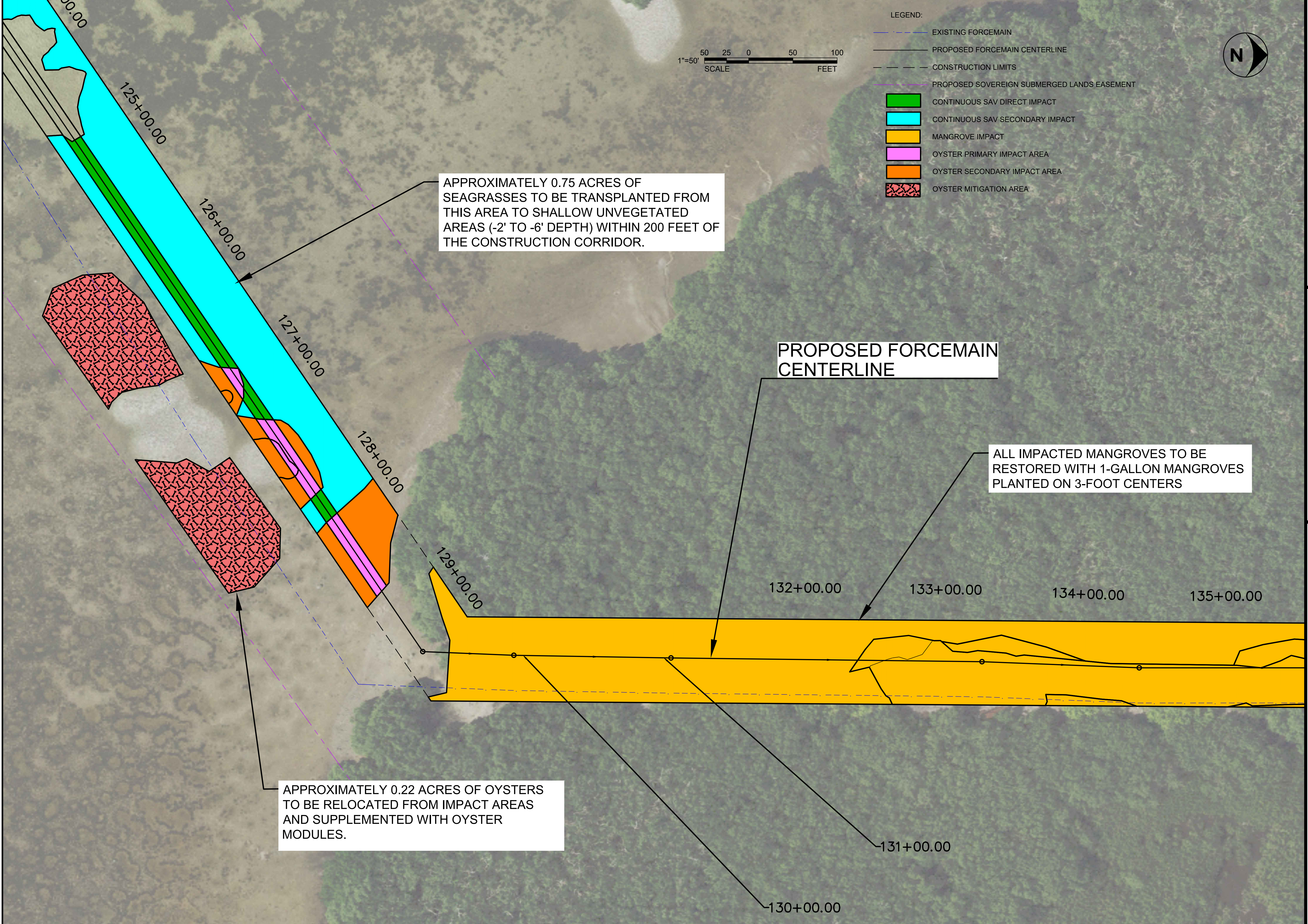
116+00.00 117+00.00 118+00.00 119+00.00 120+00.00 121+00.00 122+00.00 123+00.00 124+00.00 125+00.00 126+00.00 127+00.00

APPROXIMATELY 0.75 ACRES OF  
SEAGRASSES TO BE TRANSPLANTED FROM  
THIS AREA TO SHALLOW UNVEGETATED  
AREAS (-2' TO -6' DEPTH) WITHIN 200 FEET OF  
THE CONSTRUCTION CORRIDOR.

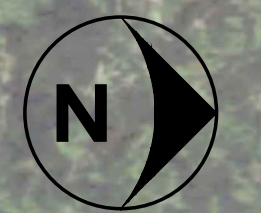
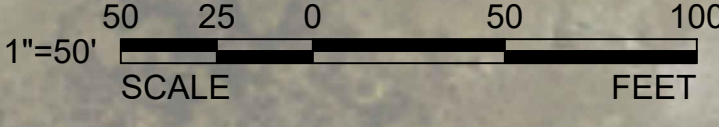
LEGEND:

-  EXISTING FORCEMAIN
-  PROPOSED FORCEMAIN CENTERLINE
-  CONSTRUCTION LIMITS
-  PROPOSED SOVEREIGN SUBMERGED LANDS EASEMENT
-  CONTINUOUS SAV DIRECT IMPACT
-  CONTINUOUS SAV SECONDARY IMPACT
-  OYSTER PRIMARY IMPACT AREA
-  OYSTER SECONDARY IMPACT AREA
-  OYSTER MITIGATION AREA





- LEGEND:
- EXISTING FORCEMAIN
  - PROPOSED FORCEMAIN CENTERLINE
  - - - CONSTRUCTION LIMITS
  - - - PROPOSED SOVEREIGN SUBMERGED LANDS EASEMENT
  - CONTINUOUS SAV DIRECT IMPACT
  - CONTINUOUS SAV SECONDARY IMPACT
  - MANGROVE IMPACT
  - OYSTER PRIMARY IMPACT AREA
  - OYSTER SECONDARY IMPACT AREA
  - OYSTER MITIGATION AREA



APPROXIMATELY 0.75 ACRES OF SEAGRASSES TO BE TRANSPLANTED FROM THIS AREA TO SHALLOW UNVEGETATED AREAS (-2' TO -6' DEPTH) WITHIN 200 FEET OF THE CONSTRUCTION CORRIDOR.

PROPOSED FORCEMAIN CENTERLINE

ALL IMPACTED MANGROVES TO BE RESTORED WITH 1-GALLON MANGROVES PLANTED ON 3-FOOT CENTERS

APPROXIMATELY 0.22 ACRES OF OYSTERS TO BE RELOCATED FROM IMPACT AREAS AND SUPPLEMENTED WITH OYSTER MODULES.

STAMP

CONSULTANT

PROJECT NAME  
**LONGBOAT KEY  
 MITIGATION PLAN**  
 501 BAY ISLES ROAD  
 LONGBOAT KEY, FL 34228

REVISIONS	#	DATE	DESCRIPTION

DESIGNED	BDF & ED
DRAWN	BDF
CHECKED	DR
IN CHARGE	BDF FL PE 70856

PROJECT NUMBER D202000016.01  
 ISSUE DATE 12/09/2021

SCALE IS AS SHOWN WHEN PLOTTED TO FULL SIZE (22"x34")  
 1" = 50'

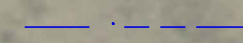

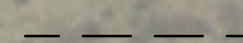

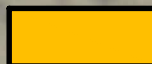
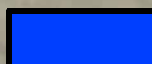
PHASE  
 60% DESIGN

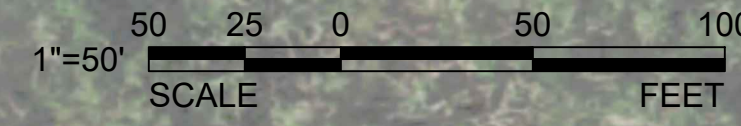
SHEET TITLE  
**EAST SHORE  
 WETLAND  
 &  
 OYSTER MITIGATION**

SHEET NUMBER  
**C-10**



LEGEND:

-  EXISTING FORCEMAIN
-  PROPOSED FORCEMAIN CENTERLINE
-  CONSTRUCTION LIMITS
-  PROPOSED SOVEREIGN SUBMERGED LANDS EASEMENT
-  MANGROVE IMPACT
-  FRESHWATER WETLAND IMPACT



4200 WEST CYPRESS ST.,  
STE. 450  
TAMPA, FL 33607  
OFFICE - 813.207.7200  
WWW.ESASSOC.COM

STAMP

CONSULTANT

LONGBOAT KEY  
MITIGATION PLAN

501 BAY ISLES ROAD  
LONGBOAT KEY, FL 34228

PROJECT NAME

REVISIONS

#	DATE	DESCRIPTION

DESIGNED	BDF & ED
DRAWN	BDF
CHECKED	DR
IN CHARGE	BDF FL PE 70856

PROJECT NUMBER D2020000016.01

ISSUE DATE 12/09/2021

SCALE IS AS SHOWN WHEN  
PLOTTED TO FULL SIZE (22"x34")  
1" = 1'

PHASE  
60% DESIGN

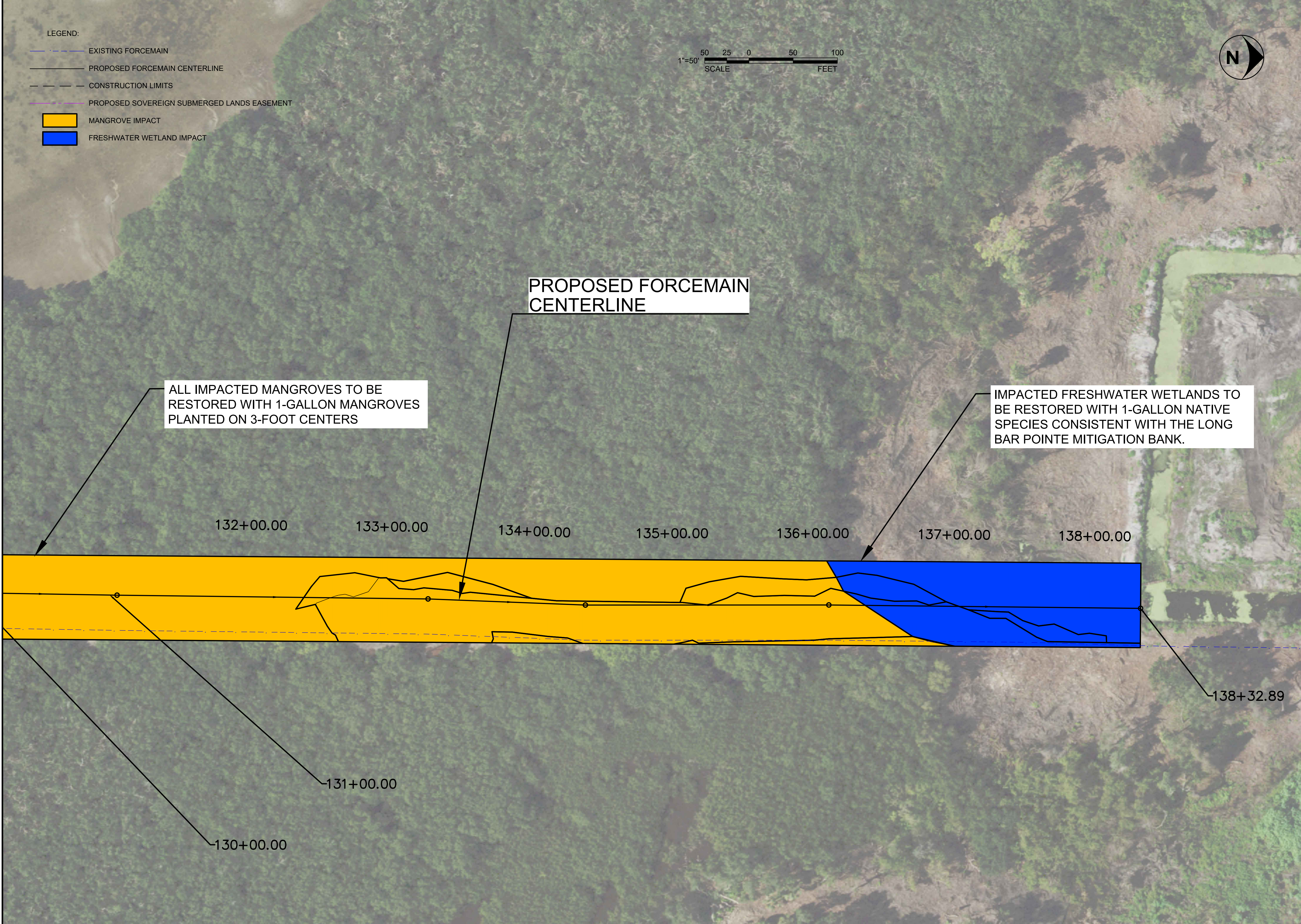
SHEET TITLE

EAST SHORE  
WETLAND  
&  
OYSTER MITIGATION

SHEET NUMBER

**C-11**

SHEET 13 OF 17







4200 WEST CYPRESS ST.,  
 STE. 450  
 TAMPA, FL 33607  
 OFFICE - 813.207.7200  
 WWW.ESASSOC.COM

STAMP

CONSULTANT

PROJECT NAME

**LONGBOAT KEY  
 MITIGATION PLAN**

501 BAY ISLES ROAD  
 LONGBOAT KEY, FL 34228

REVISIONS

#	DATE	DESCRIPTION

DESIGNED	BDF & ED
DRAWN	BDF
CHECKED	DR
IN CHARGE	BDF FL PE 70856

PROJECT NUMBER D2020000016.01

ISSUE DATE 12/09/2021

SCALE IS AS SHOWN WHEN  
 PLOTTED TO FULL SIZE (22"x34")

1" = 10'

PHASE

60% DESIGN

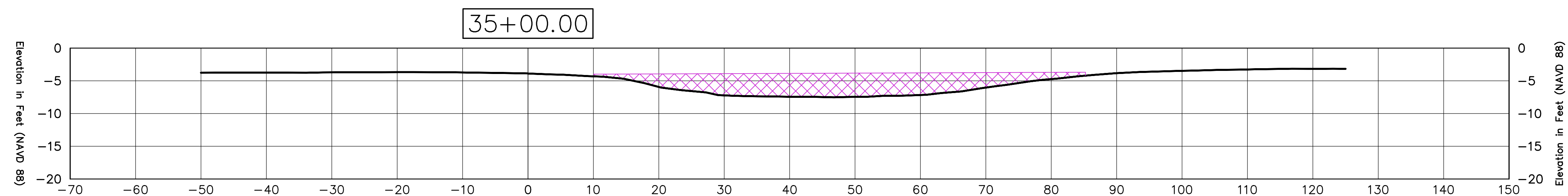
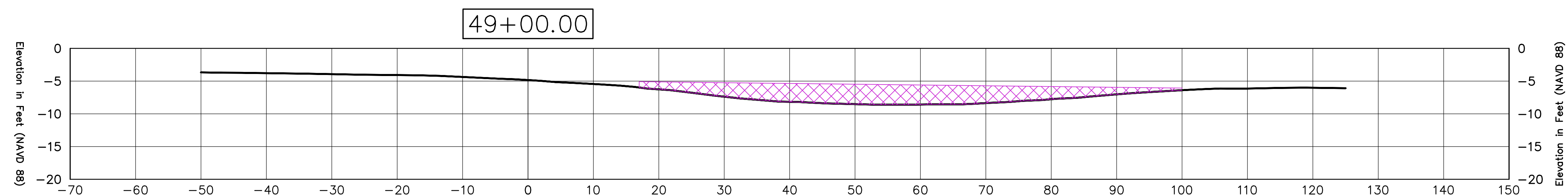
SHEET TITLE

**TYPICAL SECTIONS -  
 WEST & MIDDLE FILL  
 AREA - SAV  
 MITIGATION**


SHEET NUMBER

**C-12**

SHEET 14 OF 17



LEGEND:

 FILL AREA TO MATCH EXISTING SEDIMENT GRAIN-SIZE  
 AND MATCH EXISTING GRADE ON BOTH SIDES OF  
 PIPE DEPRESSION

VERTICAL SCALE: 1" = 10"  
 HORIZONTAL SCALE: 1" = 10'





4200 WEST CYPRESS ST.,  
STE. 450  
TAMPA, FL 33607  
OFFICE - 813.207.7200  
WWW.ESASSOC.COM

STAMP

CONSULTANT

PROJECT NAME

**LONGBOAT KEY  
MITIGATION PLAN**

501 BAY ISLES ROAD  
LONGBOAT KEY, FL 34228

REVISIONS

#	DATE	DESCRIPTION

DESIGNED	BDF & ED
DRAWN	BDF
CHECKED	DR
IN CHARGE	BDF FL PE 70856

PROJECT NUMBER D202000016.01

ISSUE DATE 12/09/2021

SCALE IS AS SHOWN WHEN  
PLOTTED TO FULL SIZE (22"x34")

1" = 10'

PHASE

60% DESIGN

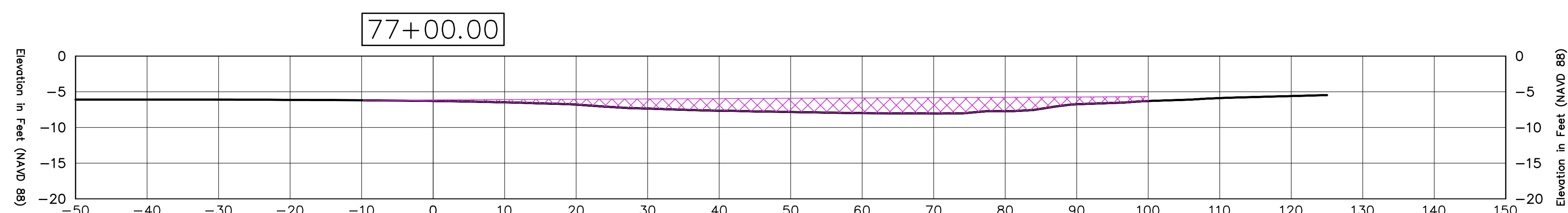
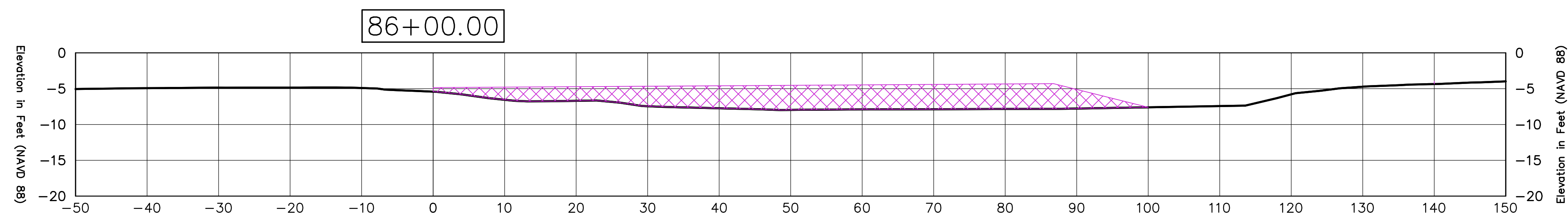
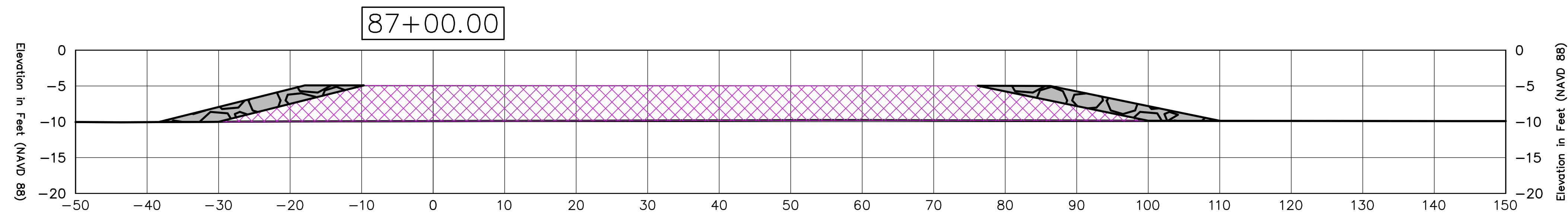
SHEET TITLE

**TYPICAL SECTIONS -  
EAST FILL AREA -  
SAV MITIGATION**

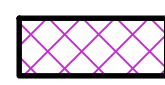

SHEET NUMBER

**C-13**

SHEET 15 OF 17



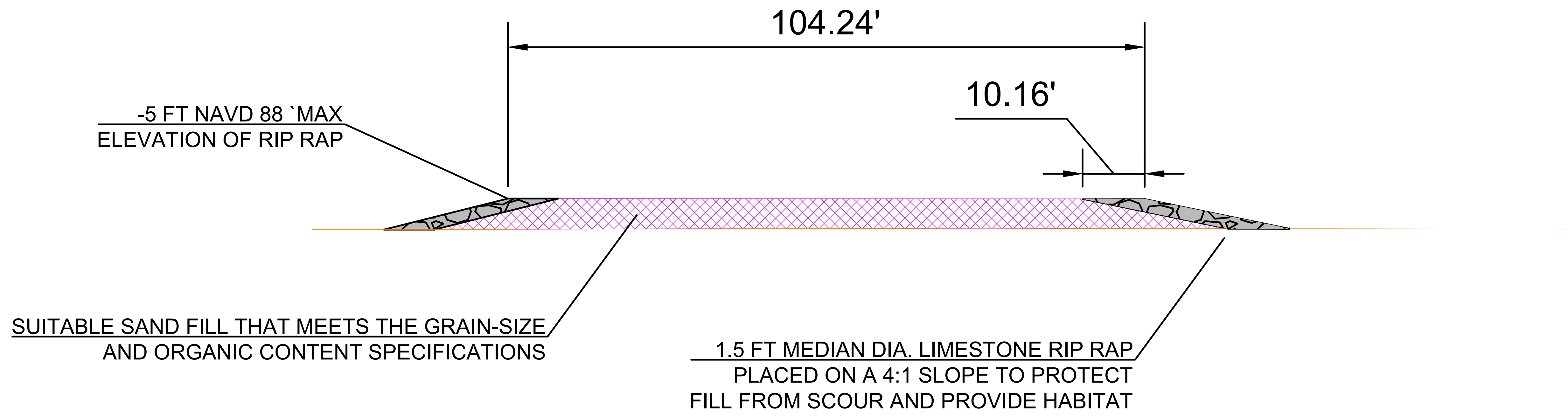
LEGEND:

-  FILL AREA TO MATCH EXISTING SEDIMENT GRAIN-SIZE AND MATCH EXISTING GRADE ON BOTH SIDES OF PIPE DEPRESSION
-  RIP RAP STABILIZATION

VERTICAL SCALE: 1" = 10"  
HORIZONTAL SCALE: 1" = 10'



# RIP RAP DETAIL



-5 FT NAVD 88 `MAX  
ELEVATION OF RIP RAP

104.24'

10.16'

SUITABLE SAND FILL THAT MEETS THE GRAIN-SIZE  
AND ORGANIC CONTENT SPECIFICATIONS

1.5 FT MEDIAN DIA. LIMESTONE RIP RAP  
PLACED ON A 4:1 SLOPE TO PROTECT  
FILL FROM SCOUR AND PROVIDE HABITAT

STAMP

CONSULTANT

PROJECT NAME  
**LONGBOAT KEY  
MITIGATION PLAN**  
501 BAY ISLES ROAD  
LONGBOAT KEY, FL 34228

REVISIONS	
#	DATE DESCRIPTION
DESIGNED	BDF & ED
DRAWN	BDF
CHECKED	DR
IN CHARGE	BDF FL PE 70856

PROJECT NUMBER D2020000016.01  
ISSUE DATE 12/09/2021

SCALE IS AS SHOWN WHEN  
PLOTTED TO FULL SIZE (22"x34")  
1" = 1'

PHASE  
60% DESIGN

SHEET TITLE  
**DETAILS**

SHEET NUMBER  
**C-14**



STAMP

CONSULTANT

**LONGBOAT KEY  
 MITIGATION PLAN**

501 BAY ISLES ROAD  
 LONGBOAT KEY, FL 34228

PROJECT NAME

REVISIONS  
 # DATE DESCRIPTION

DESIGNED BDF & ED  
 DRAWN BDF  
 CHECKED DR  
 IN CHARGE BDF  
 FL PE 70856

PROJECT NUMBER D202000016.01

ISSUE DATE 12/09/2021

SCALE IS AS SHOWN WHEN  
 PLOTTED TO FULL SIZE (22"x34")  
 1" = 1'

PHASE  
 60% DESIGN

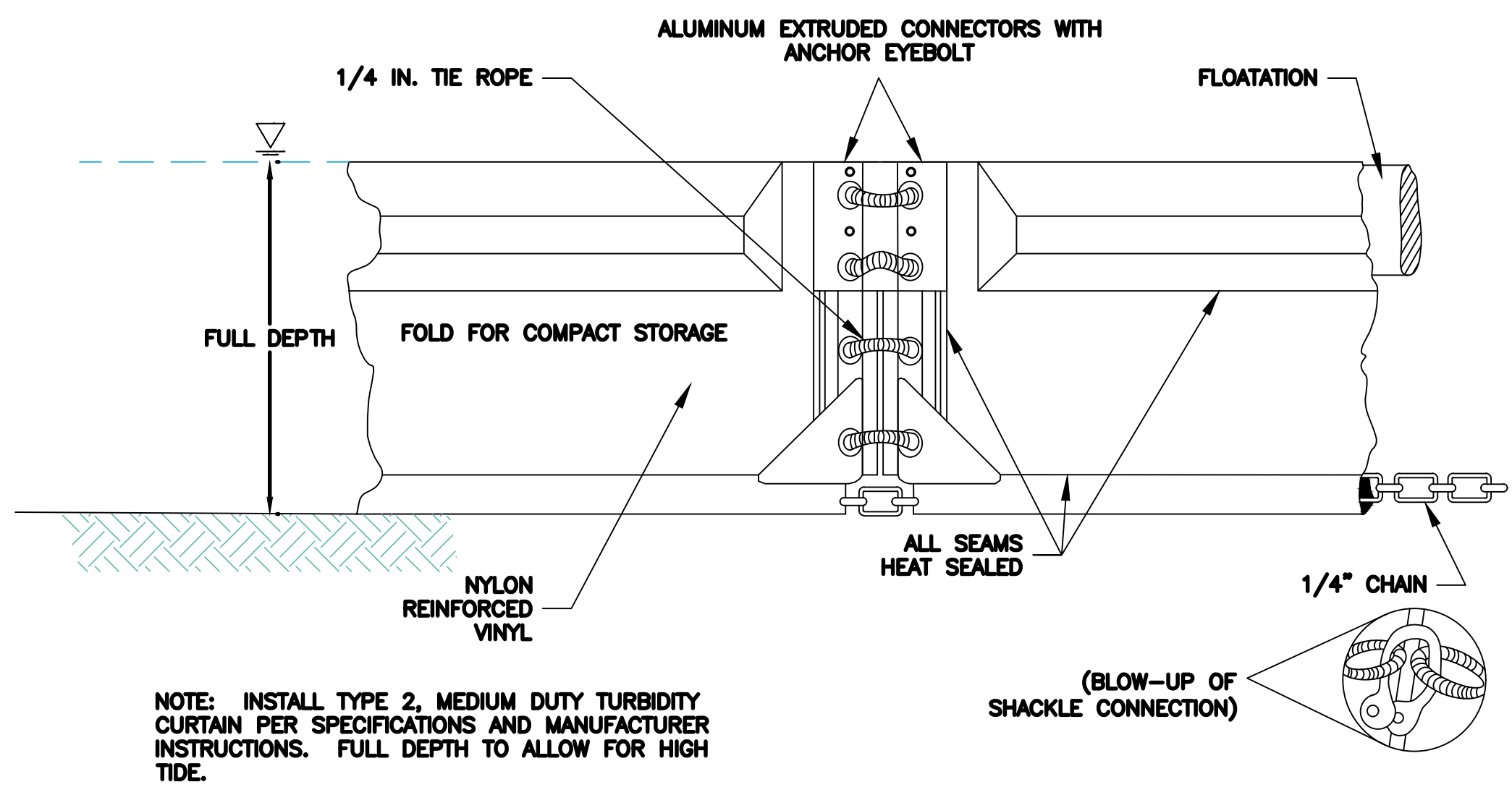
SHEET TITLE

BMP - DETAILS

SHEET NUMBER

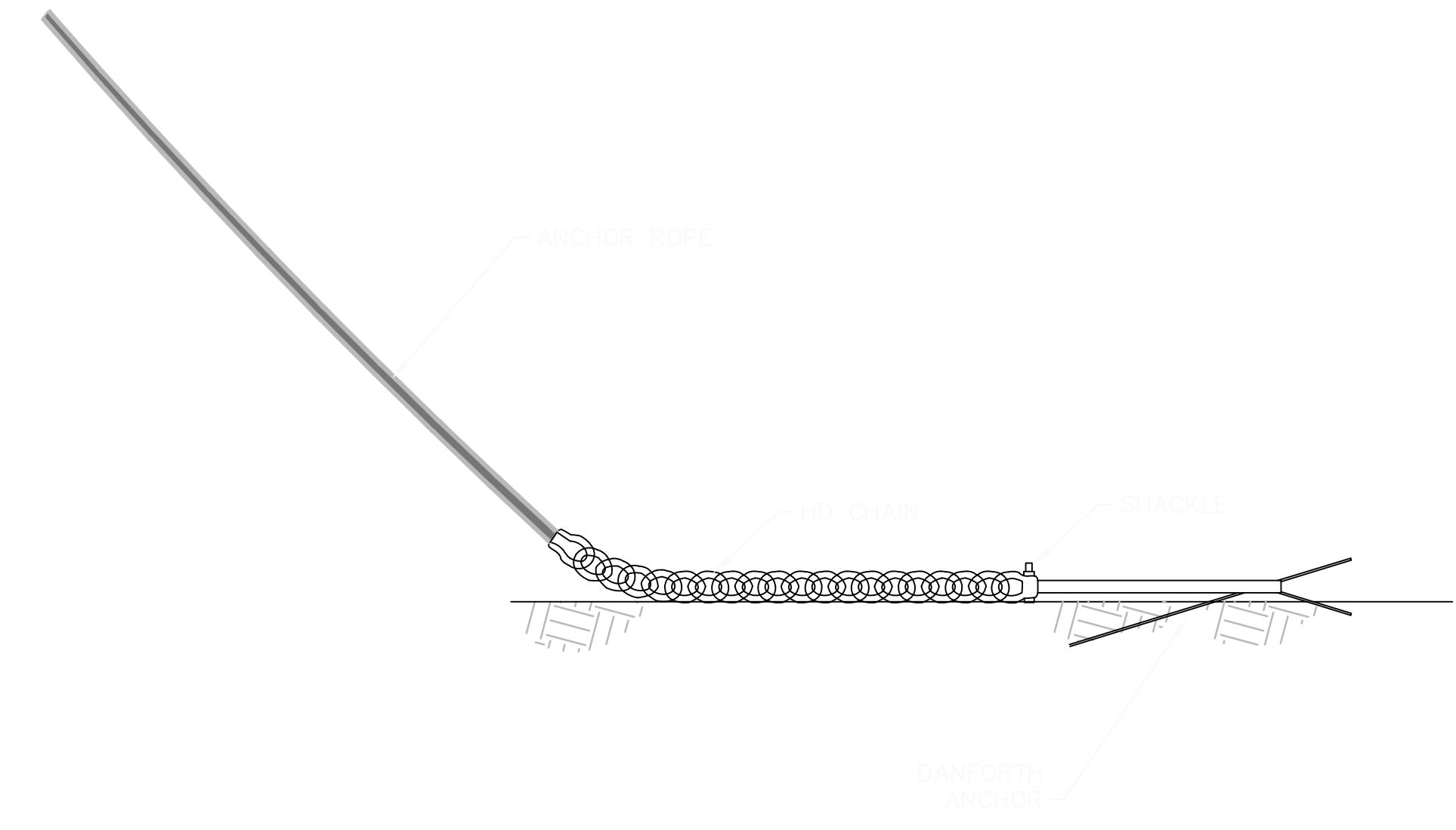
**C-15**

SHEET 17 OF 17

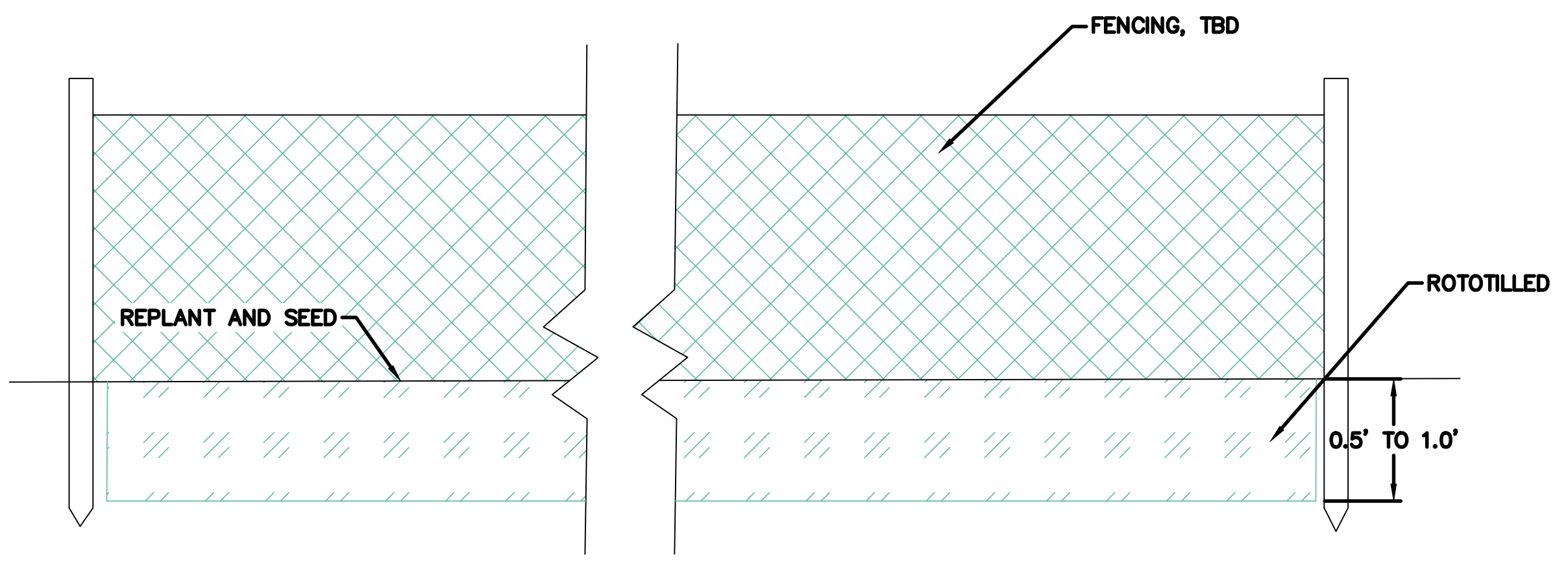


NOTE: INSTALL TYPE 2, MEDIUM DUTY TURBIDITY CURTAIN PER SPECIFICATIONS AND MANUFACTURER INSTRUCTIONS. FULL DEPTH TO ALLOW FOR HIGH TIDE.

TURBIDITY CURTAIN INSTALLATION  
 TYPICAL PROFILE VIEW NOT TO SCALE



**A** TURBIDITY CURTAIN  
 ANCHOR DETAIL NOT TO SCALE



SILT FENCE INSTALLATION  
 TYPICAL PROFILE VIEW NOT TO SCALE



---

# CONSTRUCTION COMMENCEMENT NOTICE

---

**Instructions:** In accordance with Chapter 62-330.350(1)(d), F.A.C., complete and submit this form at least 48 hours prior to commencement of activity authorized by permit.

Permit No. \_\_\_\_\_ Application No. \_\_\_\_\_  
Project Name \_\_\_\_\_ Phase \_\_\_\_\_

Construction of the system authorized by the above referenced Environmental Resource Permit and Application, is expected to commence on \_\_\_\_\_, 20\_\_\_\_  
and will have an estimated completion date of \_\_\_\_\_, 20\_\_\_\_

**PLEASE NOTE:** If the actual construction commencement date is not known within 30 days of issuance of the permit, District staff should be so notified in writing. As soon as a construction commencement date is known, the permittee shall submit a completed construction commencement notice form.

_____ Permittee's or Authorized Agent's Signature	_____ Company	
_____ Print Name	_____ Title	_____ Date
_____ E-mail	_____ Phone Number	





## As-Built Certification And Request for Conversion to Operation Phase

Instructions: Complete and submit this page within 30 days of completion of the entire project, or any independent portion of the project, as required by the permit conditions. The operation phase of the permit is effective when the construction certification for the entire permit/application is approved by the Agency. If the final operation and maintenance entity is not the permittee, the permittee shall operate the project, system, works, or other activities temporarily until such time as the transfer to the operation entity is finalized (use Form 62-330.310(2)).

Permit No: \_\_\_\_\_ Application No: \_\_\_\_\_ Permittee: \_\_\_\_\_  
 Project Name: \_\_\_\_\_ Phase or Independent Portion (if applicable): \_\_\_\_\_

I HEREBY CERTIFY THAT (please check only one box):

- To the best of my knowledge, information, and belief, construction of the project has been completed in substantial conformance with the plans specifications and conditions permitted by the Agency. Any minor deviations will not prevent the project from functioning in compliance with the requirements of Chapter 62-330, F.A.C. Attached are documents to demonstrate satisfaction of the outstanding permit conditions, other than long term monitoring and inspection requirements.
- Construction of the project was NOT completed in substantial conformance with the plans and specifications permitted by the Agency. Any deviations or independent phasing will not prevent the project from functioning in compliance with the requirements of Chapter 62-330, F.A.C. (Contact the permitting agency to determine whether a modification of the permit will be required in accordance with Rule 62-330.315, F.A.C.) Attached is a description of substantial deviations, a set of as-built drawings, and documents to demonstrate satisfaction of the outstanding permit conditions, other than long term monitoring and inspection requirements.
- Construction of the project was NOT completed in substantial conformance with the plans and specifications permitted by the Agency. There are substantial deviations that prevent the project from functioning in compliance with the requirements of Chapter 62-330, F.A.C. I acknowledge that corrections to the project and/or a modification of the permit will likely be required, and that conversion to the operation phase cannot be approved at this time. As-built or record drawings reflecting the substantial deviations are attached.

**For activities that require certification by a registered professional:**

By: \_\_\_\_\_ (Print Name) (Fla. Lic. or Reg. No.)  
Signature  
 \_\_\_\_\_ (Company Name) \_\_\_\_\_ (Company Address)  
 \_\_\_\_\_ (Telephone Number) \_\_\_\_\_ (Email Address)

AFFIX SEAL

(Date)

**For activities that do not require certification by a registered professional:**

By: \_\_\_\_\_ (Print Name)  
Signature  
 \_\_\_\_\_ (Company Name) \_\_\_\_\_ (Company Address)





(Telephone Number)

(Email Address)

(Date)





## Drawings and Information Checklist

**Following is a list of information that is to be verified and/or submitted by the Registered Professional or Permittee:**

1. All surveyed dimensions and elevations shall be certified by a registered Surveyor or Mapper under Chapter 472, F.S.
2. The registered professional's certification shall be based upon on-site observation of construction (scheduled and conducted by the registered professional of record or by a project representative under direct supervision) and review of as-built drawings, with field measurements and verification as needed, for the purpose of determining if the work was completed in accordance with original permitted construction plans, specifications, and conditions.
3. If submitted, the as-built drawings are to be based on the permitted construction drawings revised to reflect any substantial deviations made during construction. Both the original design and constructed condition must be clearly shown. The plans need to be clearly labeled as "as-built" or "record" drawings that clearly highlight (such as through "red lines" or "clouds") any substantial deviations made during construction. As required by law, all surveyed dimensions and elevations required shall be verified and signed, dated, and sealed by an appropriate registered professional. The following information, at a minimum, shall be verified on the as-built drawings, and supplemental documents if needed:
  - a. Discharge structures - Locations, dimensions and elevations of all, including weirs, orifices, gates, pumps, pipes, and oil and grease skimmers;
  - b. Detention/Retention Area(s) – Identification number, size in acres, side slopes (h:v), dimensions, elevations, contours, or cross-sections of all, sufficient to determine stage-storage relationships of the storage area and the permanent pool depth and volume below the control elevation for normally wet systems,
  - c. Side bank and underdrain filters, or exfiltration trenches - locations, dimensions, and elevations of all, including clean-outs, pipes, connections to control structures, and points of discharge to receiving waters;
  - d. System grading - dimensions, elevations, contours, final grades, or cross-sections to determine contributing drainage areas, flow directions, and conveyance of runoff to the system discharge point(s);
  - e. Conveyance - dimensions, elevations, contours, final grades, or cross-sections of systems utilized to divert off-site runoff around or through the new system;
  - f. Benchmark(s) - location and description (minimum of one per major water control structure);
  - g. Datum- All elevations should be referenced to a vertical datum clearly identified on the plans, preferably the same datum used in the permit plans.
4. Wetland mitigation or restoration areas - Show the plan view of all areas, depicting a spatial distribution of plantings conducted by zone (if plantings are required by permit), with a list showing all species planted in each zone, numbers of each species, sizes, date(s) planted, and identification of source of material; also provide the dimensions, elevations, contours, and representative cross-sections depicting the construction.
5. A map depicting the phase or independent portion of the project being certified, if all components of the project authorized in the permit are not being certified at this time.
6. Any additional information or outstanding submittals required by permit conditions or to document permit compliance, other than long-term monitoring or inspection requirements.



---

# OPERATION AND MAINTENANCE INSPECTION CERTIFICATION

---

Instructions: Submit this form to the Agency within 30 days of completion of the inspection after any failure of a stormwater management system or deviation from the permit. This form may also be used to document inspections required under Section 12.4 of Applicant's Handbook Volume I, however submittal to the Agency is not required unless requested by the Agency.

Permit No.: \_\_\_\_\_ Application No.: \_\_\_\_\_ Date Issued: \_\_\_\_\_

Identification or Name of Stormwater Management System: \_\_\_\_\_

Phase of Stormwater Management System (if applicable): \_\_\_\_\_

Inspection Date: \_\_\_\_\_

Inspection results: (check all that apply)

The undersigned hereby certifies that the works or activities are functioning in substantial conformance with the permit. This certification is based upon on-site observation of the system conducted by me or my designee under my direct supervision and my review of as-built plans.

The following maintenance was conducted since the last inspection (attach additional pages if needed):

\_\_\_\_\_

The undersigned hereby certifies that I or my designee under my direct supervision has inspected this surface water management system and the system does not appear to be functioning in substantial conformance with the permit. I am aware that maintenance or alteration is required to bring the system into substantial compliance with the terms and conditions of the permit. As appropriate, I have informed the owner of the following:

- (a) The system does not appear to be functioning properly;
- (b) That maintenance or repair is required to bring the system into compliance; and
- (c) If maintenance or repair measures are not adequate to bring the system into compliance, the system may have to be replaced or an alternative design constructed subsequent to approval by the agency below.

The following components of the system do not appear to be functioning properly (attach additional pages if needed):

---

**Any components of the constructed system that are not in substantial conformance with the permitted system shall require a written request to modify the permit in accordance with the provisions of Rule 62-330.315, F.A.C. If such modification request is not approved by the agency below, the components of the system that are not in conformance with the permit are subject to enforcement action under Sections 373.119, .129, .136, and .430, F.S.**





Name of Inspector: \_\_\_\_\_ Florida Registration Number: \_\_\_\_\_

Company Name: \_\_\_\_\_

Mailing Address: \_\_\_\_\_

City: \_\_\_\_\_ State: \_\_\_\_\_ Zip Code: \_\_\_\_\_

Phone: \_\_\_\_\_ Fax: \_\_\_\_\_ Email: \_\_\_\_\_

\_\_\_\_\_  
Signature of Inspector

\_\_\_\_\_  
Date

---

### Report Reviewed by Permittee:

Name of Permittee: \_\_\_\_\_

\_\_\_\_\_  
Signature of Permittee

\_\_\_\_\_  
Date

\_\_\_\_\_  
Title (if any)



# REQUEST FOR TRANSFER OF ENVIRONMENTAL RESOURCE PERMIT TO THE PERPETUAL OPERATION ENTITY

Instructions: Complete this form to transfer to the permit to the operation and maintenance entity. This form can be completed concurrently with, or within 30 days of approval of the As-Built Certification and Request for Conversion to Operation Phase (Form 62-330.310(1)). Please include all documentation required under Section 12.2.1(b) of Applicant's Handbook Volume 1. (see checklist below). **Failure to submit the appropriate final documents will result in the permittee remaining liable for operation and maintenance of the permitted activities.**

Permit No.:	Application No(s).
Project Name:	Phase (if applicable):

A. **REQUEST TO TRANSFER:** The permittee requests that the permit be transferred to the legal entity responsible for operation and maintenance (O&M).

By: \_\_\_\_\_

Signature of Permittee	Name and Title
Company	Company Address
Phone	City, State, Zip

B. **AGREEMENT FOR SYSTEM OPERATION AND MAINTENANCE RESPONSIBILITY:** The below-named legal entity agrees to operate and maintain the works or activities in compliance with all permit conditions and provisions of Chapter 62-330, Florida Administrative Code (F.A.C.) and Applicant's Handbook Volumes I and II in perpetuity. Authorization for any proposed modification to the permitted activities shall be applied for and obtained prior to conducting such modification.

By: \_\_\_\_\_

Signature of Representative of O&M Entity	Name of Entity for O&M
Name and Title	Address
Email Address	City, State, Zip
Phone	Date

Enclosed are the following documents, as applicable:

- Copy of recorded transfer of title to the operating entity for the common areas on which the stormwater management system is located (unless dedicated by plat)
- Copy of all recorded plats
- Copy of recorded declaration of covenants and restrictions, amendments, and associated exhibits
- Copy of filed articles of incorporation and documentary evidence of active corporate status with the Department of State, Division of Corporations (for corporations)
- A completed, signed, and notarized affidavit attesting that the operating entity meets the requirements of Section 12.3 of Environmental Resource Permit Applicant's Handbook Volume I.(Note- this is optional, but aids in processing of this request)





---

# REQUEST TO TRANSFER PERMIT

---

Instructions: Submit this form to the Agency within 30 days after any transfer of ownership or control of the real property where the permitted activity is located.

Note: Use of this form is not required when a valid permit is in the operation and maintenance phase. In such case, the owner must notify the Agency in writing within 30 days of a change in ownership or control of the entire real property, project, or activity covered by the permit. The notification may be letter, e-mail, or using this form, sent to the office that issued the permit. A processing fee is not required for this notice. The permit shall automatically transfer to the new owner or person in control, except in cases of abandonment, revocation, or modification of a permit as provided in Sections 373.426 and 373.429, F.S. (2012). If a permittee fails to provide written notice to the Agency within 30 days of the change in ownership or control, or if the change does not include the entire real property or activity covered by the permit, then the transfer must be requested using this form.

Permit No.: \_\_\_\_\_ Application No(s): \_\_\_\_\_ Date Issued: \_\_\_\_\_

Identification or Name of Surface Water Management System: \_\_\_\_\_

Phase of Surface Water Management System (if applicable): \_\_\_\_\_

## **PART 1: PROPOSED PERMIT HOLDER**

The undersigned hereby notifies the Agency that I have acquired ownership or control of the land on which the permitted system is located through the sale or other legal transfer of the land. By signing below, I hereby certify that I have sufficient real property interest or control in the land in accordance with subsection 4.2.3 (d) of Applicant's Handbook Volume I; attached is a copy of my title, easement, or other demonstration of ownership or control in the land, including any revised plats, as recorded in the Public Records. I request that the permit be modified to reflect that I agree to be the new permittee. By so doing, I acknowledge that I have examined the permit terms, conditions, and drawings, and agree to accept all rights and obligations as permittee, including agreeing to be liable for compliance with all of the permit terms and conditions, and to be liable for any corrective actions required as a result of any violations of the permit after approval of this modification by the Permitting Agency. Also attached are copies of any recorded restrictive covenants, articles of incorporation, and certificate of incorporation that may have been changed as a result of my assuming ownership or control of the lands. As necessary, I agree to furnish the Agency with demonstration that I have the ability to provide for the operation and maintenance of the system for the duration of the permit in accordance with subsection 12.3 of Applicant's Handbook Volume I.

Name of Proposed Permit Holder: \_\_\_\_\_

Mailing Address: \_\_\_\_\_

City: \_\_\_\_\_ State: \_\_\_\_\_ Zip Code: \_\_\_\_\_

Telephone: \_\_\_\_\_ Fax: \_\_\_\_\_ E-mail: \_\_\_\_\_





\_\_\_\_\_  
Signature of Proposed Permittee

\_\_\_\_\_  
Date

\_\_\_\_\_  
Title (if any)  
\_\_\_\_\_

**PART 2: RESPONSIBLE REGISTERED PROFESSIONAL**

Name of Registered Professional who will be responsible for system inspections and reporting as required by Chapter 62-330, F.A.C. (if applicable): \_\_\_\_\_

Mailing Address: \_\_\_\_\_

City: \_\_\_\_\_

State: \_\_\_\_\_

Zip Code: \_\_\_\_\_

Telephone: \_\_\_\_\_

Fax: \_\_\_\_\_

E-mail: \_\_\_\_\_

Enclosures:

Copy of recorded transfer of title for surface water management system

Copy of plat(s)

Copy of recorded restrictive covenants, articles of incorporation, and certificate of incorporation

Other